

## Chapter 24 Hydrocarbon

### Aliphatic Hydrocarbon

Organic compounds composed of only carbon and hydrogen are called hydrocarbons. Hydrocarbons are two types

(1) *Aliphatic Hydrocarbon (Alkanes, Alkenes and Alkynes).*

(2) *Aromatic Hydrocarbon (Arenes)*

#### (1) Sources of aliphatic hydrocarbon

Mineral oil or crude oil, petroleum [Petra → rock; oleum → oil] is the dark colour oily liquid with offensive odour found at various depths in many regions below the surface of the earth. It is generally found under the rocks of earth's crust and often floats over salted water.

#### (2) Composition

(i) **Alkanes** : found 30 to 70% contain upto 40 carbon atom. Alkanes are mostly straight chain but some are branched chain isomers.

(ii) **Cycloalkanes** : Found 16 to 64% cycloalkanes present in petroleum are; cyclohexane, methyl cyclopentane etc. cycloalkanes rich oil is called asphaltic oil.

(iii) **Aromatic hydrocarbon** : found 8 to 15% compound present in petroleum are; Benzene, Toluene, Xylene, Naphthalene etc.

(iv) **Sulphur, nitrogen and oxygen compound** : Sulphur compound present to the extent of 6% include mercaptans [R-SH] and sulphides [R-S-R]. The

unpleasant smell of petroleum is due to sulphur compounds. Nitrogenous compounds are pyridines, quinolines and pyrroles. Oxygen compounds present in petroleum are. Alcohols, Phenols and resins. Compounds like chlorophyll, haemin are also present in it.

(v) **Natural gas** : It is a mixture of Methane (80%), Ethane (13%), Propane (3%), Butane (1%), Vapours of low boiling pentanes and hexanes (0.5%) and Nitrogen (1.3%). L.P.G. Contain butanes and pentanes and used as cooking gas. It is highly inflammable. This contain, methane, nitrogen and ethane.

(vi) **C.N.G.** : When natural gas compressed at very high pressure is called compressed natural gas (CNG). Natural gas has octane rating of 130 it consists, mainly of methane and may contain, small amount of ethane and propane.

(3) **Theories of origin of petroleum** : Theories must explain the following characteristics associated with petroleum,

Its association with brine (sodium chloride solution). The presence of nitrogen and sulphur compounds in it. The presence of chlorophyll and haemin in it. Its optically active nature. Three important theories are as follows.

(i) *Mendeleeff's carbide theory or inorganic theory*



## 1082 Hydrocarbon

(ii) *Engler's theory or organic theory*

(iii) *Modern theory*

(4) **Mining of petroleum** : Petroleum deposits occurs at varying depth at different places ranging from 500 to 15000 feet. This is brought to the surface by artificial drilling.

(5) **Petroleum refining** : Separation of useful fractions by fractional distillation is called petroleum refining.

**Table : 24.1**

Fraction	Boiling range (°C)	Approximate composition	Uses
Uncondensed gases	Upto room temperature	C <sub>1</sub> - C <sub>4</sub>	Fuel gases: refrigerants; production of carbon black, hydrogen; synthesis of organic chemicals.
Crude naphtha on refractionation yields,	30 - 150°	C <sub>5</sub> - C <sub>10</sub>	
(i) Petroleum ether	30 - 70°	C <sub>5</sub> - C <sub>6</sub>	Solvent
(ii) Petrol or gasoline	70 - 120°	C <sub>6</sub> - C <sub>8</sub>	Motor fuel; drycleaning; petrol gas.
(iii) Benzene derivatives	120 - 150°	C <sub>8</sub> - C <sub>10</sub>	Solvent; drycleaning
Kerosene oil	150 - 250°	C <sub>11</sub> - C <sub>16</sub>	Fuel; illuminant; oil gas
Heavy oil	250 - 400°	C <sub>15</sub> - C <sub>18</sub>	As fuel for diesel engines; converted to gasoline by cracking.
Refractionation gives,			
(i) Gas oil, (ii) Fuel oil, (iii) Diesel oil			
Residual oil on fractionation by vacuum distillation gives,	Above 400°	C <sub>17</sub> - C <sub>40</sub>	
(i) Lubricating oil		C <sub>17</sub> - C <sub>20</sub>	Lubrication
(ii) Paraffin wax		C <sub>20</sub> - C <sub>30</sub>	Candles; boot polish; wax paper; etc
(iii) Vaseline		C <sub>20</sub> - C <sub>30</sub>	Toilets; ointments; lubrication.
(iv) Pitch		C <sub>30</sub> - C <sub>40</sub>	Paints, road surfacing
Petroleum coke (on redistilling tar)			As fuel.

### (6) Purification

(i) **Treatment with concentrated sulphuric acid** : The gasoline or kerosene oil fraction is shaken with sulphuric acid to remove aromatic compounds like thiophene and other sulphur compound with impart offensive odour to gasoline and kerosene and also make them corrosive.

(ii) **Doctor sweetening process** :

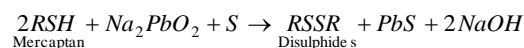

(iii) **Treatment with adsorbents** : Various fractions are passed over adsorbents like alumina, silica or clay etc, when the undesirable compounds get adsorbed.

(7) **Artificial method for manufacture of Petrol or gasoline**

(i) Cracking, (ii) Synthesis

(i) **Cracking** : It is a process in which high boiling fractions consisting of higher hydrocarbons are heated strongly to decompose them into lower hydrocarbons with low boiling points. Cracking is carried out in two different ways.

(a) **Liquid phase cracking** : In this process, the heavy oil or residual oil is cracked at a high temperature (475 – 530°C) under high pressure (7 to 70 atmospheric pressure). The high pressure keeps the reaction product in liquid state. The conversion is approximately 70% and the resulting petrol has the octane number in the range 65 to 70.

The cracking can be done in presence of some catalysts like silica, zinc oxide, titanium oxide, ferric oxide and alumina. The yields of petrol are generally high when catalyst is used.

(b) **Vapour phase cracking** : In this process, kerosene oil or gas oil is cracked in vapour phase. The temperature is kept 600 – 800°C and the pressure is about 3.5 to 10.5 atmospheres. The cracking is facilitated by use of a suitable catalyst. The yields are about 70%.

(ii) **Synthesis** : Two methods are applicable for synthesis.

(a) **Bergius process** : This method was invented by Bergius in Germany during first world war.

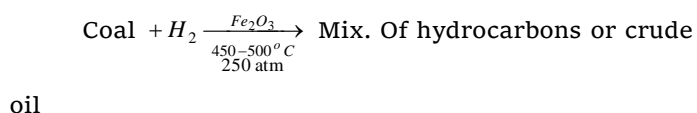

(b) **Fischer-tropsch process** : The overall yield of this method is slightly higher than Bergius process.

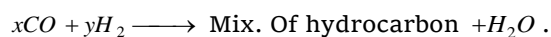
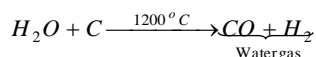

The best catalyst for this process is a mixture of cobalt (100 parts), thoria, (5 parts), magnesia (8 parts) and kieselguhr (200 parts).

### Characteristics of hydrocarbons

(1) **Knocking** : The metallic sound during working of an internal combustion engine is termed as knocking.

“The greater the compression greater will be efficiency of engine.” The fuel which has minimum knocking property is always preferred.

**The tendency to knock falls off in the following order** : Straight chain alkanes > branched chain alkanes > olefins > cyclo alkanes > aromatic hydrocarbons.

(2) **Octane number** : It is used for measuring the knocking character of fuel used in petrol engine. The octane number of a given sample may be defined as the percentage by volume of iso-octane present in a mixture of iso-octane and *n*-heptane which has the same knocking performance as the fuel itself.

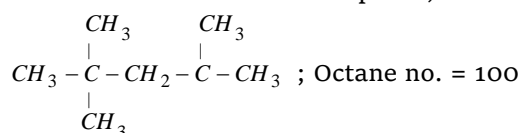
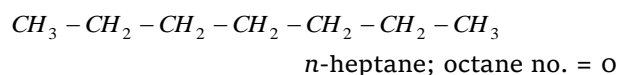

2, 2, 4-Trimethyl pentane or Iso-octane.

**For example** : a given sample has the knocking performance equivalent to a mixture containing 60% iso-octane and 40% heptane. The octane number of the gasoline is, therefore, 60.

Presence of following types of compounds increases the octane number of gasoline.

(i) In case of straight chain hydrocarbons octane number decreases with increase in the length of the chain.

(ii) Branching of chain increases the value of octane number

(iii) Introduction of double bond or triple bond increases the value of octane number.

(iv) Cyclic alkanes have relatively higher value of octane number.

(v) The octane number of aromatic hydrocarbons are exceptionally high

(vi) By adding gasoline additives (eg TEL)

(3) **Antiknock compounds** : To reduce the knocking property or to improve the octane number of a fuel certain chemicals are added to it. These are called **antiknock compounds**. One such compound, which is extensively used, is tetraethyl lead (TEL). TEL is used in the form of following mixture,

TEL = 63%, Ethylene bromide = 26%, Ethylene chloride = 9% and a dye = 2%.

However, there is a disadvantage that the lead is deposited in the engine. To remove the free lead, the ethylene halides are added which combine with lead to form volatile lead halides.

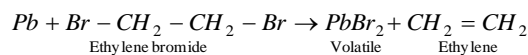

However, use of TEL in petrol is facing a serious problem of Lead pollution, to avoid this a new compound cyclopenta dienyl manganese carbonyl

## 1084 Hydrocarbon

(called as AK-33-X) is used in developed countries as antiknocking compound.

(4) **Other methods of improving octane number of hydrocarbon.**

(i) **Isomerisation** [Reforming] : By passing an alkane over  $AlCl_3$  at  $200^\circ C$ .

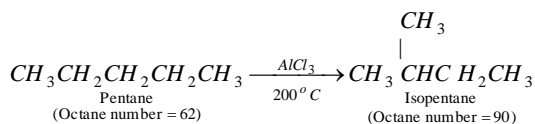

(ii) **Alkylation** :

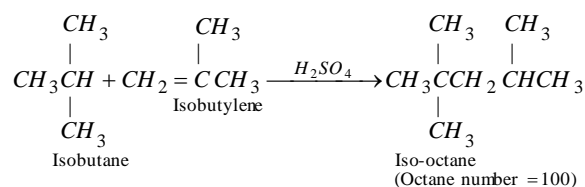

(iii) **Aromatisation** :

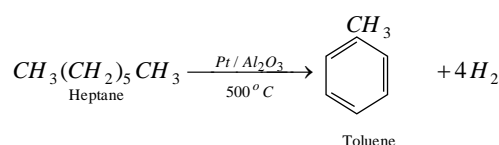

The octane no. of petrol can thus be improved.

- By increasing the proportion of branched chain or cyclic alkanes.
- By addition of aromatic hydrocarbons Benzene, Toluene and Xylene (BTX).
- By addition of methanol or ethanol.
- By addition of tetraethyl lead  $(C_2H_5)_4Pb$

(5) **Cetane number** : It is used for grading the diesel oils.

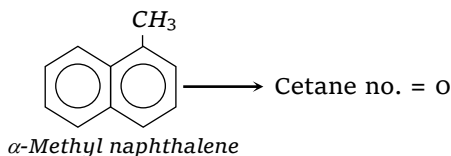

The cetane number of a diesel oil is the percentage of cetane (hexadecane) by volume in a mixture of cetane and  $\alpha$ -methyl naphthalene which has the same ignition property as the fuel oil under consideration.

(6) **Flash point** : The lowest temperature at which an oil gives sufficient vapours to form an explosive mixture with air is referred to as flash point of the oil.

The flash point in India is fixed at  $44^\circ C$ , in France it is fixed at  $35^\circ C$ , and in England at  $22.8^\circ C$ . The flash point of an oil is usually determined by means of "**Abel's apparatus**".

Chemists have prepared some hydrocarbons with octane number even less than zero (e.g., *n*-nonane has octane number - 45) as well as hydrocarbon with octane number greater than 100 (e.g., 2, 2, 3 trimethylbutane. has octane number of 124).

(7) **Petrochemicals** : All such chemicals which are derived from petroleum or natural gas called petrochemicals. Some chemicals which are obtained from petroleum are summarised in table :

**Table : 24.2**

Hydrocarbons	Compounds derived
Methane	Methyl chloride, chloroform, methanol, formaldehyde, formic acid, freon, hydrogen for synthesis of ammonia.
Ethane	Ethyl chloride, ethyl bromide, acetic acid, acetaldehyde, ethylene, ethyl acetate, nitroethane, acetic anhydride.
Ethylene	Ethanol, ethylene oxide, glycol, vinyl chloride, glyoxal, polyethene, styrene, butadiene, acetic acid.
Propane	Propanol, propionic acid, isopropyl ether, acetone, nitromethane, nitroethane, nitropropane.
Propylene	Glycerol, allyl alcohol, isopropyl alcohol, acrolein, nitroglycerine, dodecylbenzene, cumene, bakelite.
Hexane	Benzene, DDT, gammexane.
Heptane	Toluene
Cycloalkanes	Benzene, toluene, xylenes, adipic acid.
Benzene	Ethyl benzene, styrene, phenol, BHC (insecticide), adipic acid, nylon, cyclohexane, ABS detergents.
Toluene	Benzoic acid, TNT benzaldehyde, saccharin, chloramine-T, benzyl chloride, benzal chloride.

### Alkanes [Paraffines]

"Alkanes are saturated hydrocarbon containing only carbon-carbon single bond in their molecules."

Alkanes are less reactive so called paraffins; because under normal conditions alkanes do not react with acids, bases, oxidising agents and reducing agent.

General formula :  $C_nH_{2n+2}$

Examples are  $CH_4, C_2H_6, C_3H_8$ ,

(1) **General Methods of preparation**

(i) **By catalytic hydrogenation of alkenes and alkynes** (Sabatie and sanderen's reaction)

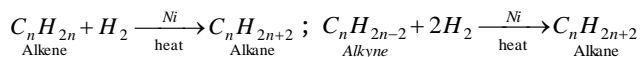

□ Methane is not prepared by this method

(ii) **Birch reduction :**

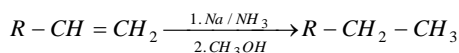

(iii) **From alkyl halide**

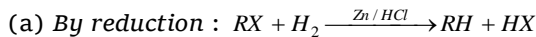

(b) **With hydrogen in presence of pt/pd :**

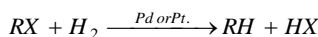

(c) **With HI in presence of Red phosphorus :**

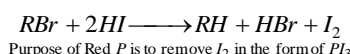

(iv) **By Zn-Cu couple :**

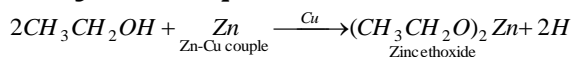

(v) **Wurtz reaction :**

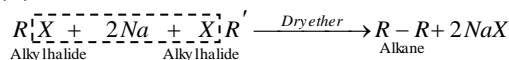

□  $R-Br$  or  $RI$  preferred in this reaction. The net result in this reaction is the formation of even no. of carbon atoms in molecules.

(vi) **Frankland's reaction :**

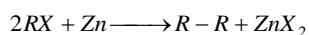

(vii) **Corey-house synthesis**

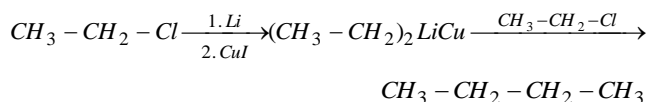

□ Reaction is suitable for odd number of Alkanes.

(viii) **From Grignard reagent**

(a) **By action of acidic 'H' :**

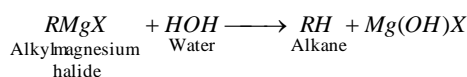

(b) **By reaction with alkyl halide :**



(ix) **From carboxylic acids**

(a) **Laboratory method** [Decarboxylation reaction or Duma reaction]

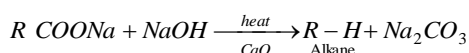

□  $NaOH$  and  $CaO$  is in the ratio of 3 : 1. (Sodalime)

(b) **Kolbe's synthesis :**

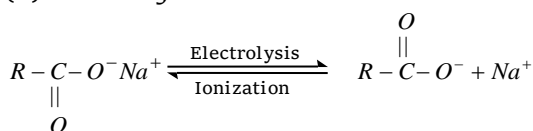

**At anode** [Oxidation] :

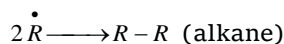
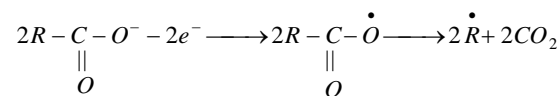

**At cathode** [Reduction] :

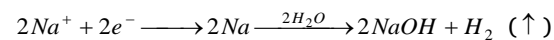

□ Both ionic and free radical mechanism are involved in this reaction.

(c) **Reduction of carboxylic acid :**

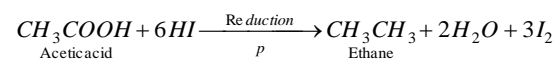

(x) **By reduction of alcohols, aldehyde, ketones or acid derivatives**

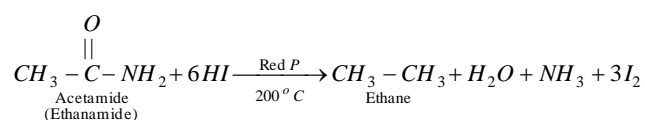
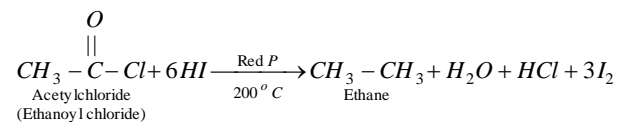
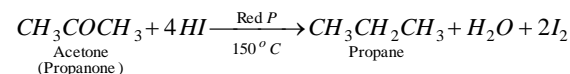
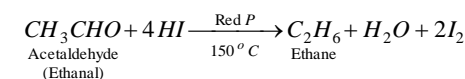
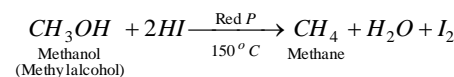

□ Aldehyde and ketones when reduced with amalgamated zinc and conc.  $HCl$  also yield alkanes.

**Clemmenson reduction :**

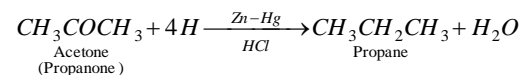
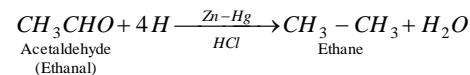

□ Aldehydes and ketones ( $>C=O$ ) can be reduced to hydrocarbon in presence of excess of hydrazine and sodium alkoxide on heating.

**Wolff-kishner reduction :**

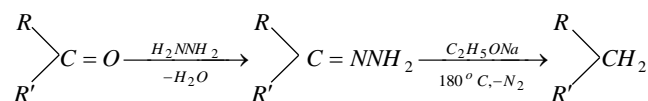

(xi) **Hydroboration of alkenes**

(a) **On treatment with acetic acid**

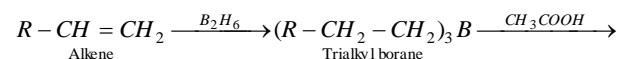

## 1086 Hydrocarbon

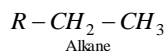

(b) *Coupling of alkyl boranes by means of silver nitrate*

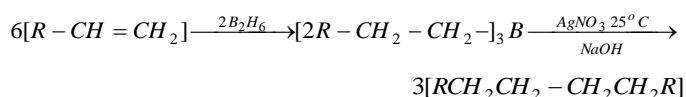

### (2) Physical Properties

(i) **Physical state** : Alkanes are colourless, odourless and tasteless.

Alkanes                      State

$C_1 - C_4$                       Gaseous state

$C_5 - C_{17}$                       Liquid state [Except neo pentane which is gas]

$C_{18}$  and above              Solid like waxes

(ii) **Density** : Alkanes are lighter than water.

(iii) **Solubility** : Insoluble in water, soluble in organic solvents, solubility  $\propto \frac{1}{\text{Molecular mass}}$

(iv) **Boiling points and Melting points** : Melting points and boiling points.  $\propto \frac{1}{\text{No. of branches}}$

Alkane :	$C_3H_8$	$C_4H_{10}$	$C_5H_{12}$	$C_6H_{14}$	$C_7H_{16}$	$C_8H_{18}$
M.P.(K ) :	85.9	138	143.3	179	182.5	216.2

□ Melting points of even > Odd no. of carbon atoms, this is because, the alkanes with even number of carbon atoms have more symmetrical structure and result in closer packing in the crystal structure as compared to alkanes with odd number of carbon atoms.

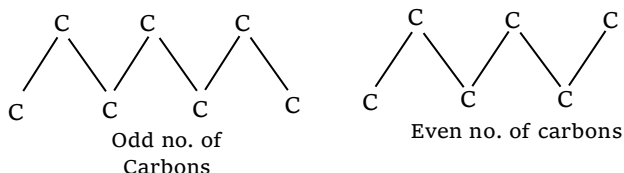

### (3) Chemical properties

(i) **Substitution reactions of Alkanes**

(a) **Halogenation** :  $R-H + X-X \longrightarrow R-X + HX$

The reactivity of halogen is :  $F_2 > Cl_2 > Br_2 > I_2$

□ Fluorine can react in dark  $Cl_2, Br_2$  require light energy.  $I_2$  doesnot show any reaction at room temperature, but on heating it shows iodination.

□ Iodination of methane is done in presence of oxidising agent such as  $HNO_3 / HIO_3 / HgO$  which neutralises  $HI$ .

□ **Chlorination of methane** :

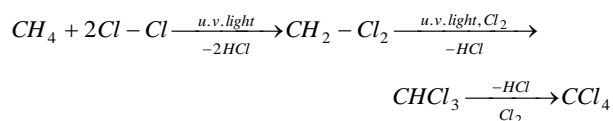

(ii) **Reaction based on free radical mechanism**

(a) **Nitration** :

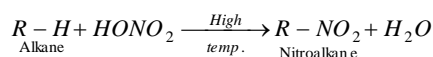

Nitrating mixture : (i) ( $Con.HNO_3 + Con.H_2SO_4$ ) at  $250^\circ C$

(ii) ( $HNO_3$  vapour at  $400^\circ - 500^\circ C$ ).

(b) **Sulphonation** : Free radical mechanism

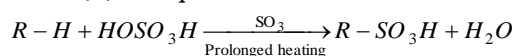

□ Lower alkanes particularly methane, ethane, do not give this reaction.

(iii) **Oxidation**

(a) **Complete Oxidation or combustion** :

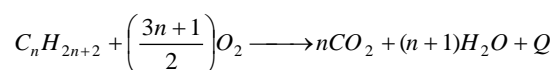

□ This is exothermic reaction.

(b) **Incomplete combustion or oxidation**

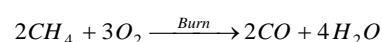

(c) **Catalytic Oxidation** :

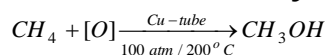

This is the industrial method for the manufacture of methyl alcohol.

□ Higher alkanes are oxidised to fatty acids in presence of manganese stearate.

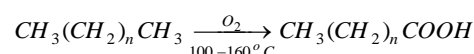

(d) **Chemical oxidation** :

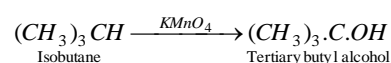

(iv) **Thermal decomposition or cracking or pyrolysis or fragmentation**

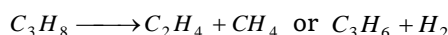
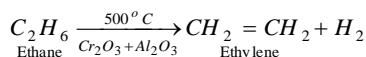
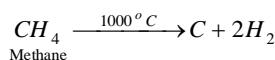

□ This reaction is of great importance to petroleum industry.

(v) **Isomerisation :**

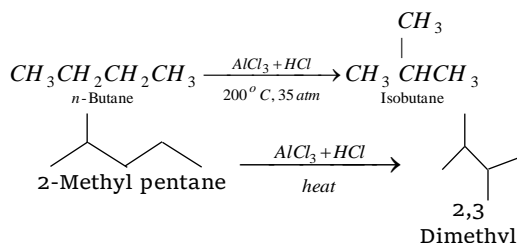

(vi) **Aromatisation :**

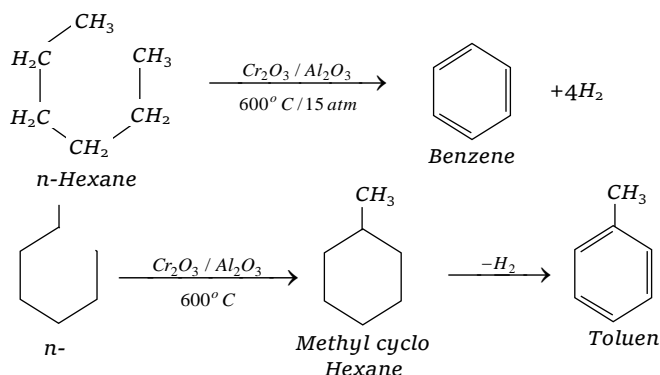

(vii) **Step up reaction**

(a) **Reaction with  $\text{CH}_2\text{N}_2$  (Diazo methane) :**

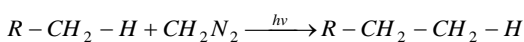

(b) **Reaction with  $\text{CHCl}_3 / \text{NaOH}$  :**

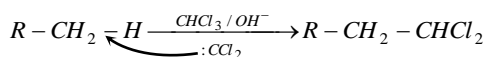

(c) **Reaction with  $\text{CH}_2 = \text{C}$  :**

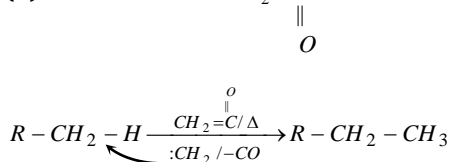

(viii) **HCN formation :**

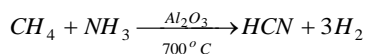
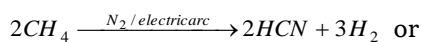

(ix) **Chloro sulphonation/Reaction with  $\text{SO}_2 + \text{Cl}_2$**

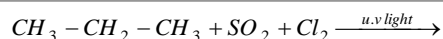

This reaction is known as reed's reaction.

□ This is used in the commercial formation of detergent.

(x) **Action of steam :**

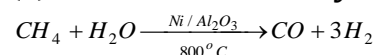

### Individual members of alkanes

(1) **Methane :** Known as *marsh gas*.

(i) **Industrial method of preparation :** Methane gas is obtained on a large scale from natural gas by liquefaction. It can also be obtained by the application of following methods,

(a) **From carbon monoxide :** A mixture of carbon monoxide and hydrogen is passed over a catalyst containing nickel and carbon at  $250^\circ\text{C}$  when methane is formed.

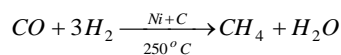

(b) **Bacterial decomposition of cellulose material present in sewage water :** This method is being used in England for production of methane.

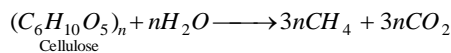

(c) **Synthesis :** □ By striking an electric arc between carbon electrodes in an atmosphere of hydrogen at  $1200^\circ\text{C}$ , methane is formed.

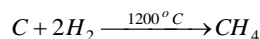

By passing a mixture of hydrogen sulphide and carbon disulphide vapour through red hot copper, methane is formed.

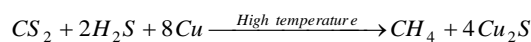

(ii) **Physical properties**

(a) It is a colourless, odourless, tasteless and non-poisonous gas.

(b) It is lighter than air. Its density at NTP is 0.71 g/L.

(c) It is slightly soluble in water but is fairly soluble in ether, alcohol and acetone.

(d) Its melting point is  $-182.5^\circ\text{C}$  and boiling point is  $-161.5^\circ\text{C}$ .

(iii) **Uses**

(a) In the manufacture of compounds like methyl alcohol, formaldehyde, methyl chloride, chloroform, carbon tetrachloride, etc.

(b) In the manufacture of hydrogen, used for making ammonia.

(c) In the preparation of carbon black which is used for making printing ink, black paints and as a filler in rubber vulcanisation.

## 1088 Hydrocarbon

(d) As a fuel and illuminant.

(2) **Ethane**

(i) **Methods of preparation**

(a) **Laboratory method of preparation :**

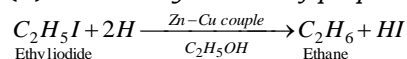

(b) **Industrial method of preparation :**

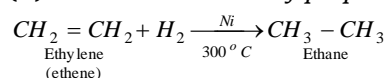

(ii) **Physical properties**

(a) It is a colourless, odourless, tasteless and non-poisonous gas.

(b) It is very slightly soluble in water but fairly soluble in alcohol, acetone, ether, etc.

(c) Its density at NTP is 1.34 g/L

(d) It boils at  $-89^\circ C$ . Its melting point is  $-172^\circ C$ .

(iii) **Uses**

(a) As a fuel. (b) For making hexachloroethane which is an artificial camphor.

(3) **Interconversion of Alkanes**

**Ascent of alkane series,**

(i) **Methane to ethane :**

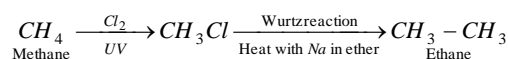

(ii) **Butane from ethane :**

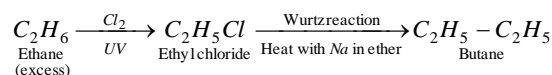

**Descent of alkane series :** Use of decarboxylation reaction is made. It is a multistep conversion.

**Ethane to methane**

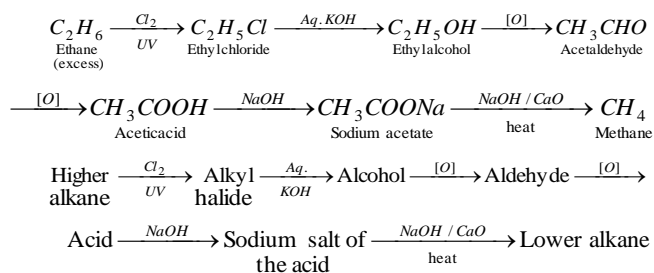

## Alkenes

These are the acyclic hydrocarbon in which carbon-carbon contain double bond. These are also known as olefins, because lower alkene react with halogens to form oily substances. General formula is  $C_nH_{2n}$ . Examples,  $C_2H_4, C_3H_6, C_4H_8$ .

(1) **Preparation methods**

(i) **From Alkynes :**

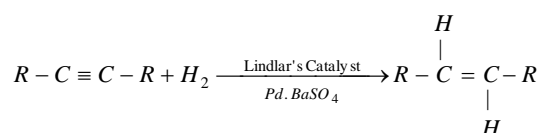

□ Poison's catalyst such as  $BaSO_4, CaCO_3$  are used to stop the reaction after the formation of alkene.

(ii) **From mono halides :**

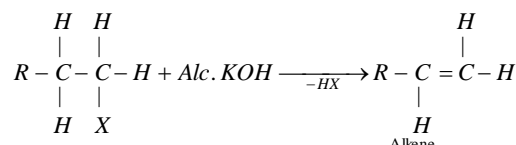

□ If we use alc.  $NaOH$  in place of  $KOH$  then trans product is formed in majority because of its stability. According to saytzeff rule.

(iii) **From dihalides**

(a) **From Gem dihalides**

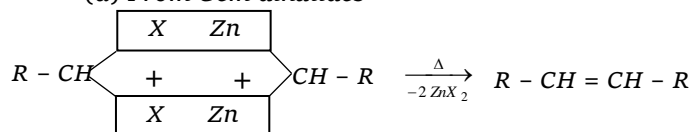

□ If we take two different types of gemdihalides then we get three different types of alkenes.

□ Above reaction is used in the formation of symmetrical alkenes only.

(b) **From vicinal dihalides :**

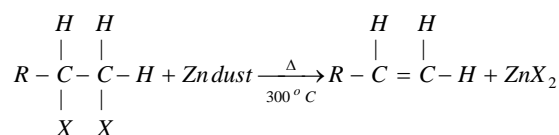

□ Alkene is not formed from 1, 3 dihalides. Cycloalkanes are formed by dehalogenation of it.

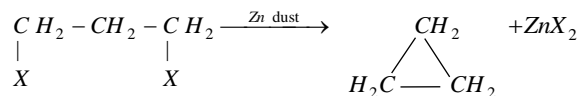

(iv) **By action of  $NaI$  on vicinal dihalide :**

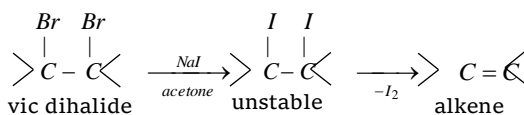

(v) **From alcohols [Laboratory method] :**

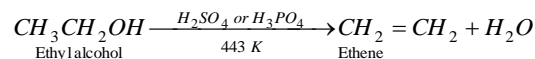

(vi) **Kolbe's reaction :**

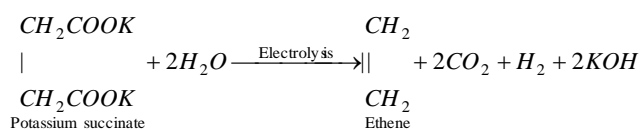

(vii) **From esters [Pyrolysis of ester] :**

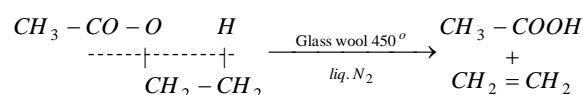





## 1090 Hydrocarbon

(v) **Birch reduction** : This reaction is believed to proceed via anionic free radical mechanism.

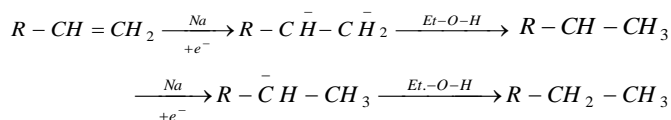

(vi) **Halogenation**

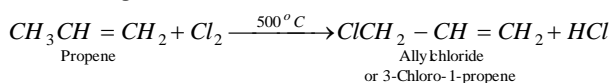

□ If NBS [N-bromo succinimide] is a reagent used for the specific purpose of brominating alkenes at the allylic position.

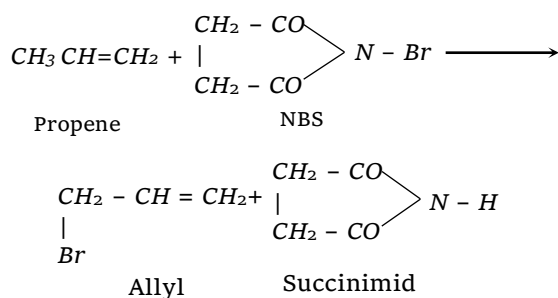

□ In presence of polar medium alkene form vicinal dihalide with halogen.

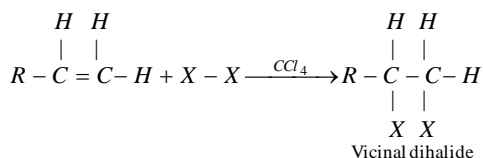

Reactivity of halogen is  $F_2 > Cl_2 > Br_2 > I_2$

(vii) **Reaction with HX** [Hydrohalogenation]

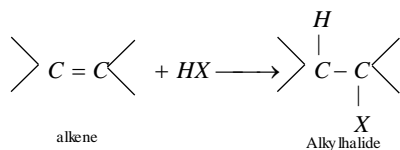

According to markownikoff's rule and kharasch effect.

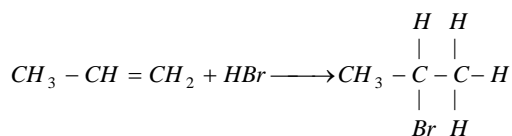

According to Anti Markownikoff rule (Based on F.R.M.)  $CH_3-CH=CH_2 + HBr \xrightarrow{\text{Peroxide}}$

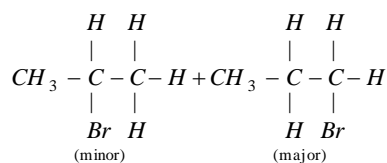

(viii) **Reaction with hypohalous acids** :

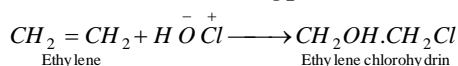

□ In case of unsymmetrical alkenes markownikoff rule is followed.

(ix) **Reaction with sulphuric acid** :

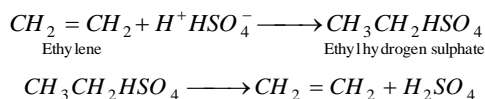

□ This reaction is used in the separation of alkene from a gaseous mixture of alkanes and alkenes.

(x) **Reaction with nitrosyl chloride**

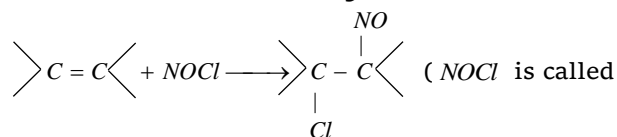

Tillden reagent)

□ If hydrogen is attached to the carbon atom of product, the product changes to more stable oxime.

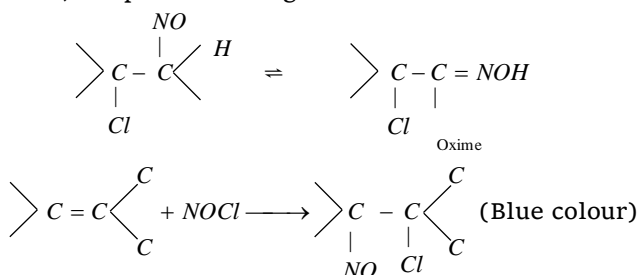

(xi) **Oxidation** : With alkaline  $KMnO_4$  [Bayer's reagent] : This reaction is used as a test of unsaturation.

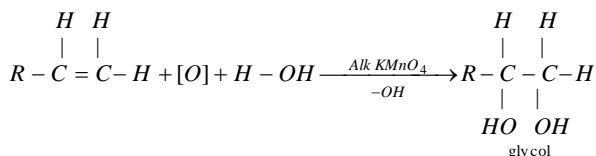

With acidic  $KMnO_4$  :

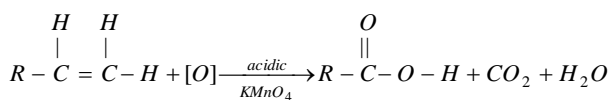

(xii) **Hydroxylation**

(a) Using per oxy acid :

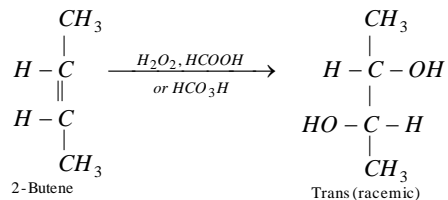

(b) Hydroxylation by  $OsO_4$  :

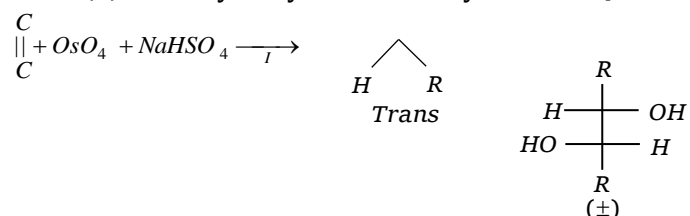

□ If per benzoic acid or peroxy acetic acid is used then oxirane are formed.

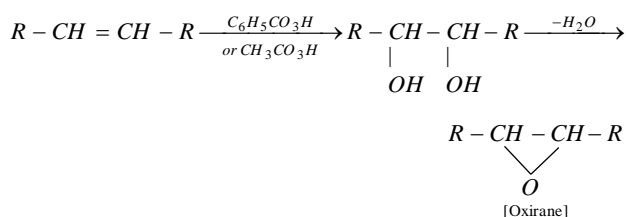

(xiii) **Combustion** :

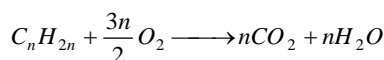

They burn with luminous flame and form explosive mixture with air or oxygen.

(xiv) **Ozonolysis**

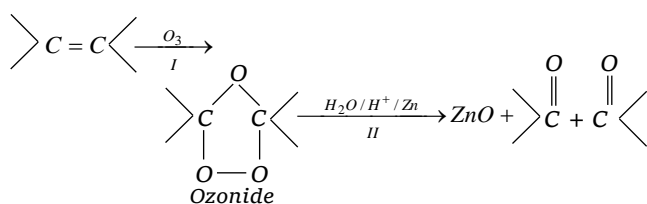

□ Application of ozonolysis : This process is quite useful to locate the position of double bond in an alkene molecule. The double bond is obtained by joining the carbon atoms. of the two carbonyl compounds.

(xv) **Oxy - mercuration demercuration** : With mercuric acetate (in THF), followed by reduction with  $NaBH_4 / NaOH$  is also an example of hydration of alkene according to markownikoff's rule.

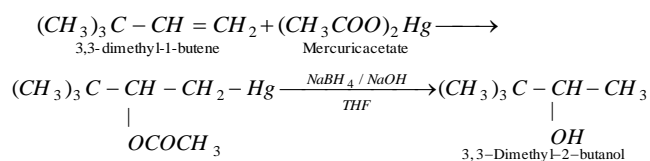

(xvi) **Epoxidation**

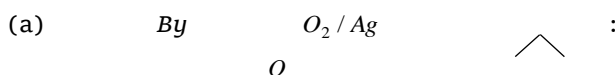

(b) Epoxidation by performic acid or perbenzoic acid :

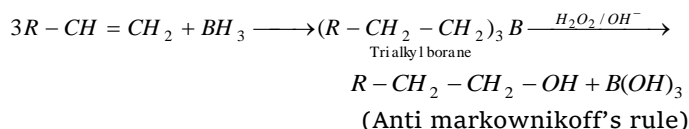
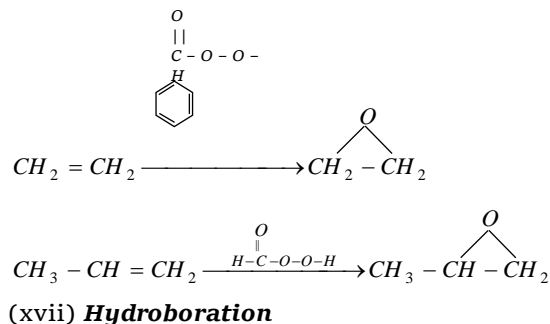

(xviii) **Hydroformylation** :

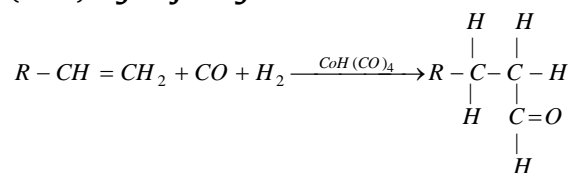

□ If  $CO + H_2O$  is taken then respective acid is formed.

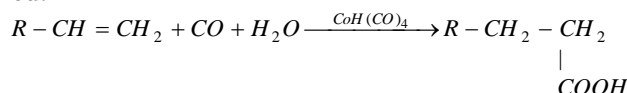

(xix) **Addition of formaldehyde**

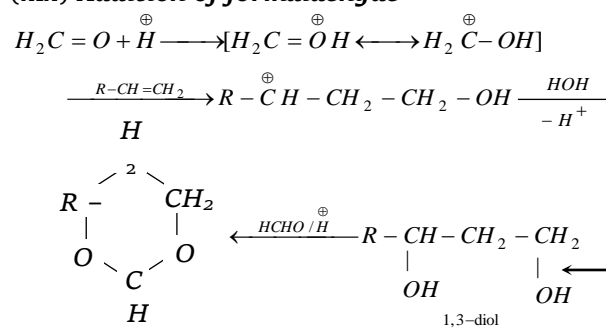

(xx) **Polymerisation**

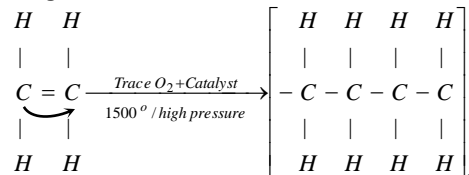

□ If in polymerisation zeigler-natta catalyst  $[(R)_3Al + TiCl_4]$  is used then polymerisation is known as zeigler-natta polymerisation.

(xxi) **Isomerisation** :

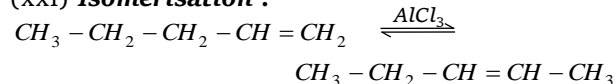

The mechanism proceeds via carbocation.

(xxii) **Addition of  $HNO_3$**  :

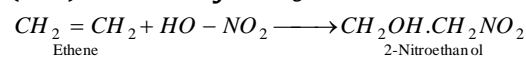

(xxiii) **Addition of Acetyl chloride** :

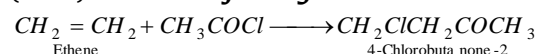

(4) **Uses**

(i) For the manufacture of polythene - a plastic material; (ii) For artificial ripening of fruits; (iii) As a general anaesthetic; (iv) As a starting material for a large number of compounds such as glycol, ethyl halides, ethyl alcohol, ethylene oxide, etc; (v) For making poisonous mustard gas (War gas); (vi) For making ethylene-oxygen flame.

**Alkynes**

## 1092 Hydrocarbon

These are the acyclic hydrocarbons which contain carbon-carbon triple bond are called alkynes. General formula is  $C_nH_{2n-2}$ . Ex. Ethyne  $CH \equiv CH$ ; Propyne  $CH_3 - C \equiv CH$

### (1) General methods of preparation

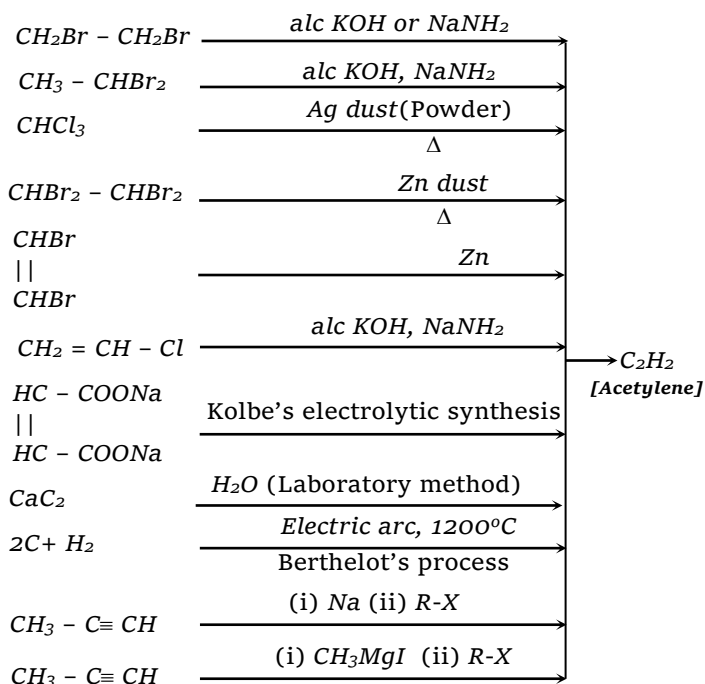

❑ In reaction with gem dihalide, Alc. KOH is not used for elimination in 2<sup>nd</sup> step.

❑ In reaction with vicinal dihalide, if the reactant is 2-butylene chloride then product is 2-butyne as major product.

**Preparation of higher alkynes** (by metal acetylide)

❑ Acetylene gives salt with  $NaNH_2$  or  $AgNO_3$  (ammonical) which react with alkyl halide to give higher alkyne.

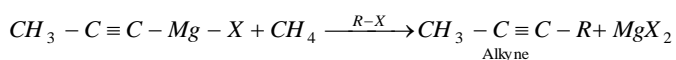
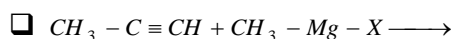
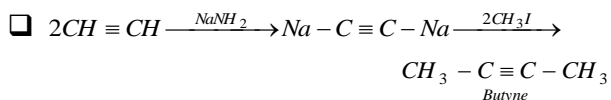

### (2) Physical properties

(i) Acetylene is a colourless gas. It has a garlic odour. The odour is due to presence of impurities of phosphorous and hydrogen sulphide. However, pure acetylene has pleasant odour.

(ii) It is insoluble in water but highly soluble in acetone and alcohol. Acetylene is transported under

high pressure in acetone soaked on porous material packed in steel cylinders.

(iii) Its boiling point is  $-84^\circ C$ .

(iv) It is lighter than air. It is somewhat poisonous in nature.

(v) It burns with luminous flame and forms explosive mixture with air.

(3) **Chemical reactivity of alkynes** :  $C \equiv C$  is less reactive than the carbon-carbon double bond towards electrophilic addition reaction. This is because in alkyne carbon has more S-character so more strongly will be the attraction for  $\pi$  electrons. Alkyne also undergo nucleophilic addition with electron rich reagents. Ex. Addition of water, cyanide, carboxylic acid, alcohols. Nucleophilic addition can be explained on the basis that alkynes form vinylic carbanion which is more stable than alkyl carbanion formed by alkene

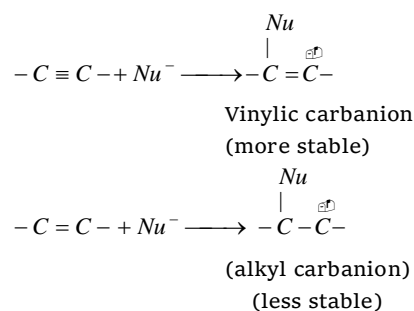

(i) **Acidity of alkynes** : Acetylene and other terminal alkynes (1- alkynes) are weakly acidic in character

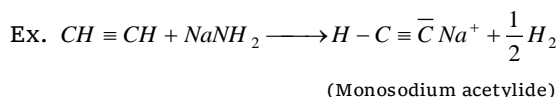

The acetylenic hydrogen of alkynes can be replaced by copper (I) and silver (I) ions. They react with ammonical solutions of cuprous chloride and silver nitrate to form the corresponding copper and silver alkynides.

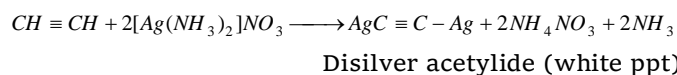
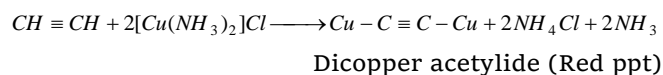

This reaction can be used to distinguish between 2-alkynes and 1-alkynes. 1-alkynes will give this test while 2-alkynes, will not give this test.

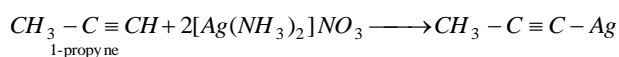

$CH_3 - C \equiv C - CH_3 + 2[Ag(NH_3)_2]NO_3 \longrightarrow$  No reaction

**Explanation for the acidic character :** It explained by  $sp$  hybridisation. We know that an electron in  $s$ -orbital is more tightly held than in a  $p$ -orbital. In  $sp$  hybridisation  $s$ -character is more (50%) as compared to  $sp^2$  (33%) or  $sp^3$  (25%), due to large  $s$ -character the carbon atom is quite electronegative.

(ii) **Reaction with formaldehyde**

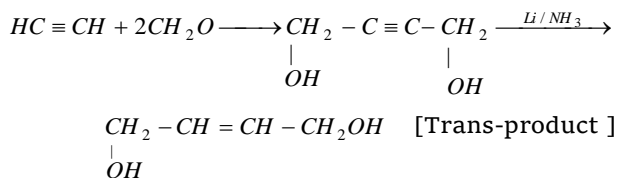

(4) **Chemical properties of acetylene**

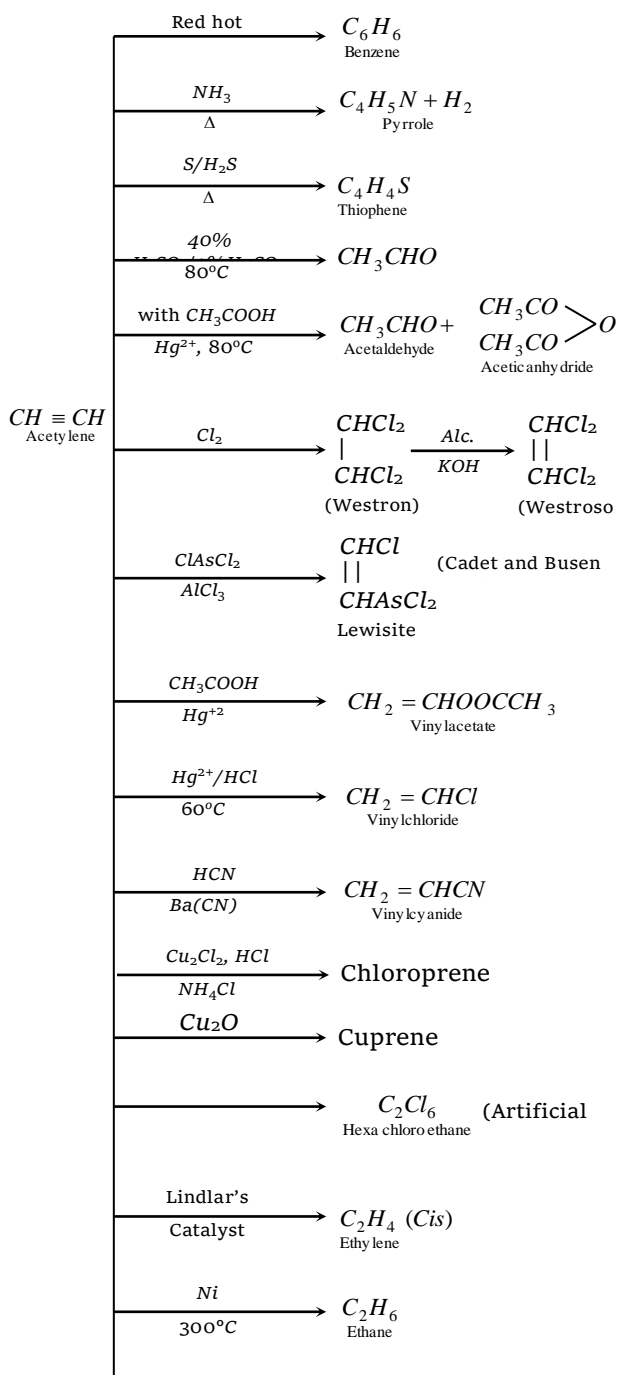

**Oxidative-Hydroboration :** Alkynes react with  $BH_3$  (in THF) and finally converted into carbonyl compounds.

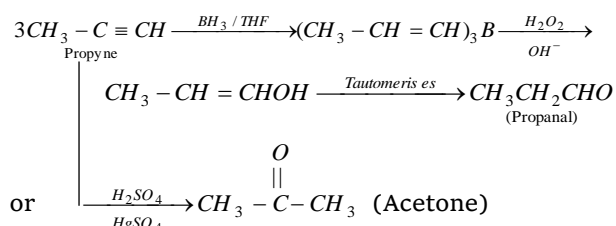

Thus it is useful for preparing aldehyde from terminal alkyne.

**Reduction of Alkyne :** Alkynes add on hydrogen in presence of suitable catalysts like finely divided  $Ni$ ,  $Pd$ .

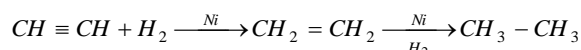

If the triple bond is not present at the end of the carbon chain of the molecule, the alkene formed may be cis and trans depending upon the choice of reducing agents.

With  $Na/NH_3$  or  $Li/NH_3$  in (liquid ammonia) trans alkene is almost an exclusive product while catalytic reduction at alkyne affords mainly cis alkenes.

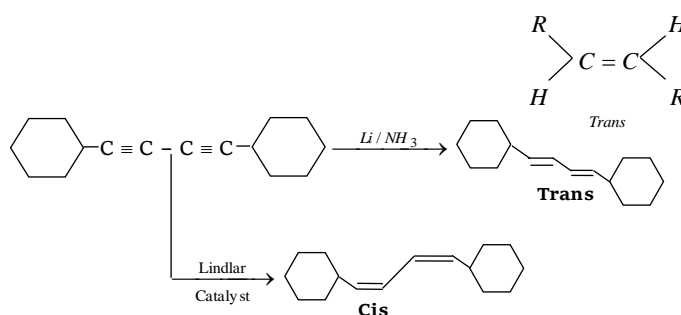
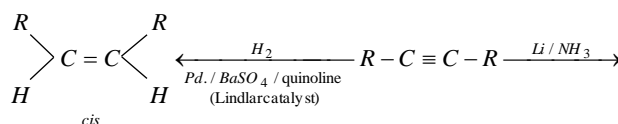

**Degree of unsaturation** : The number of degree of unsaturation in a hydrocarbon is given by

$$\frac{2n_1 + 2 - n_2}{2}, \text{ Where } n_1 \text{ is the number of carbon}$$

atoms;  $n_2$  is the number of hydrogen atoms.

For example in  $C_6H_{12}$ , the degree of unsaturation is  $= \frac{2 \times 6 + 2 - 12}{2} = 1$

### Tests of unsaturation

(a) **Baeyer's reagent** : It is 1%  $KMnO_4$  solution containing sodium carbonate. It has pink colour. An aqueous solution of the compound, a few drops of Baeyer's reagent are added, the pink colour of the solution disappears. The decolourisation of pink colour indicates the presence of unsaturation in the compound.

□ Alkene without any hydrogen atom on the

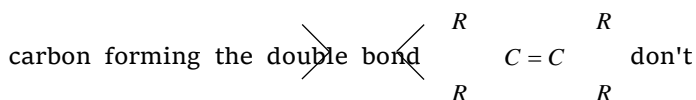

show this test.

(b) **Bromine- carbon tetrachloride test** : The compound is dissolved in carbon tetrachloride or chloroform and then a few drops of 5% bromine solution in carbon tetrachloride are added to it, the colour of bromine disappears. It indicates the presence of unsaturation.

□ This test also fails in the case of alkene of the

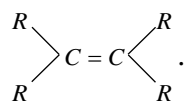

### (5) Uses

(i) Acetylene is used as an illuminant.  
(ii) It is used for the production of oxy-acetylene flame. The temperature of the flame is above  $3000^\circ C$ . It is employed for cutting and welding of metals.

(iii) Acetylene is used for artificial ripening of fruits.

(iv) It is used as a general anaesthetic under the name naracylene.

(v) Acetylene has synthetic applications. It serves as a starting material for the manufacture of a large variety of substances.

(vi) On electrical decomposition acetylene produces finely divided carbon and hydrogen. Hydrogen is used in airships.  $C_2H_2 \longrightarrow 2C + H_2$

### (6) Interconversion

(i) **Conversion of ethane into ethene** : (Alkane into alkene)

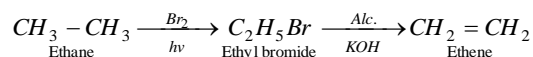

(ii) **Ethene into ethane** : (Alkene into alkane)

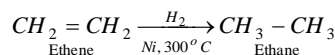

(iii) **Ethane into ethyne (acetylene)** : i.e., alkane into alkyne

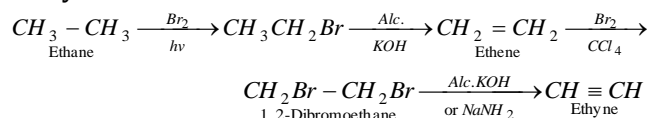

(iv) **Ethyne into ethane** : (Alkyne into alkane)

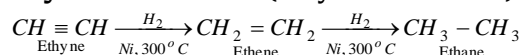

(v) **Ethene into propene : Ascending in alkene series**

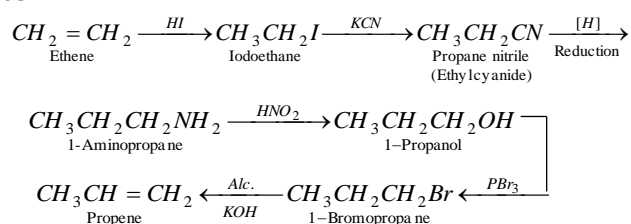

or

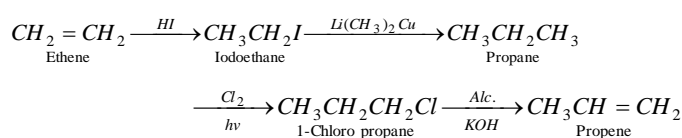

or  $CH_2 = CH_2 \xrightarrow{HI} CH_3CH_2I \xrightarrow{CH_3I/Na} CH_3CH_2CH_3$

Propene                      Propene

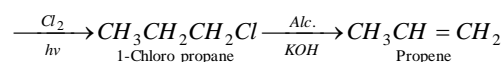

(vi) **Propene into ethene** : Descending an alkene series

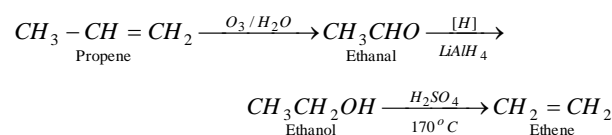

(vii) **Acetylene into propyne (methyl acetylene)** : (Ascent)

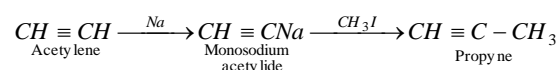

(viii) **Propyne into acetylene** : (Descent)

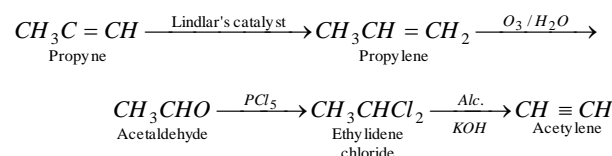

(ix) **1-Butyne into 2-pentyne** : (Ascent)









**Stability of conjugated dienes :** It is explained on the basis of delocalisation of electron cloud between carbon atoms.

The four  $\pi$  electrons of 1, 3-butadiene are delocalised over all the four atoms. This delocalisation of the  $\pi$  electrons makes the molecule more stable.

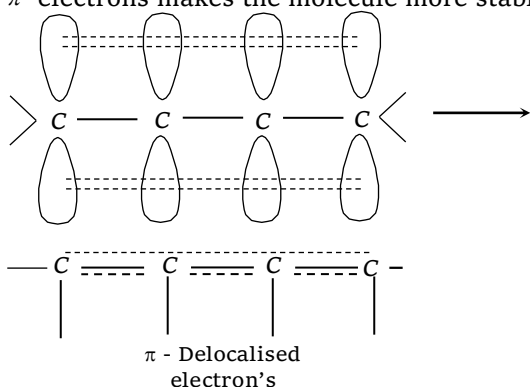

(v) **Ozonolysis :**

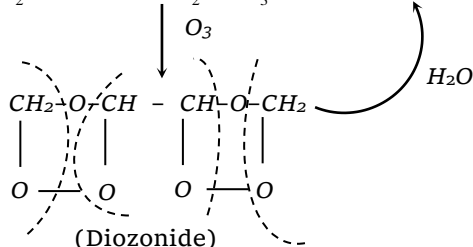
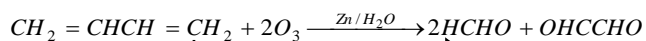

## Aromatic Hydrocarbon

### (1) Source of Arenes

Source of arenes is coal. It contains benzene, xylene, naphthalene etc. Arenes are obtained by destructive distillation of coal.

### (2) Distillation of coal

#### COAL

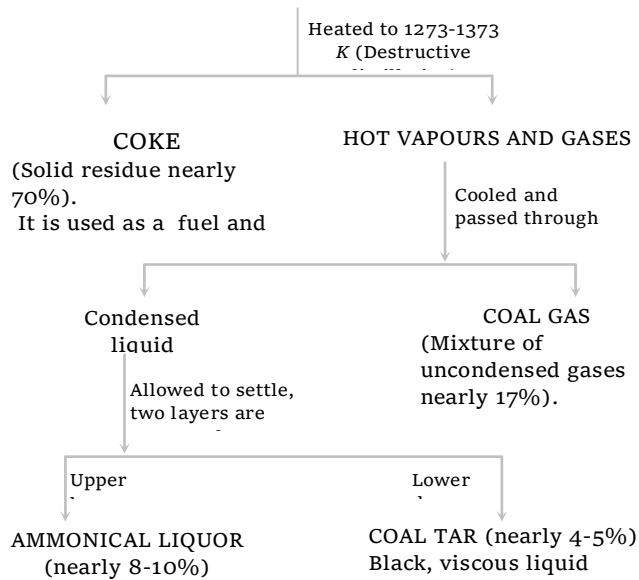

□ Coal tar is a mixture of large numbers of arenes.

(3) **Distillation of coal tar :** Arenes are isolated by fractional distillation of coal tar,

Table : 24.4

Name of the fraction	Temperature range (K)	Main constituents
Light oil (or crude oil) fraction	Upto 443	Benzene, toluene, xylene
Middle oil fraction (Carbolic oil)	443-503	Phenol, naphthalene, pyridine
Heavy oil fraction (Creosote oil)	503-543	Naphthalene, naphthol and cresol
Green oil (Anthracene oil)	543-633	Anthracene, phenanthrene
Pitch (left as residue)	Non-volatile	Carbon

□ The residue left after fractional distillation of coal-tar is called pitch.

### (4) Isolation of benzene

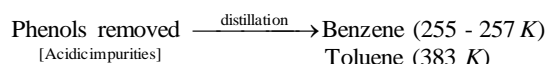
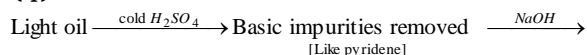

## General characteristics of arenes

(1) All arenes have general formula  $[\text{C}_n\text{H}_{2n-6y}]$ . Where  $y$  is number of benzene rings and  $n$  is not less than 6.

(2) Arenes are cyclic and planar. They undergo substitution rather than addition reactions.

(3) **Aromaticity or aromatic character :** The characteristic behaviour of aromatic compounds is called aromaticity. Aromaticity is due to extensive delocalisation of  $\pi$ -electrons in planar ring system. Huckel (1931) explained aromaticity on the basis of following rule.

**Huckel rule :** For aromaticity the molecule must be planar, cyclic system having delocalised  $(4n + 2)\pi$  electrons where  $n$  is an integer equal to 0, 1, 2, 3,-----.

Thus, the aromatic compounds have delocalised electron cloud of 2, 6, 10 or 14  $\pi$  electrons.

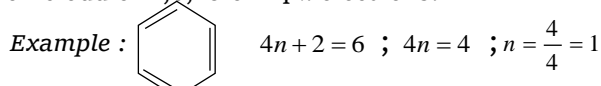

Benzene  $6\pi$  electrons

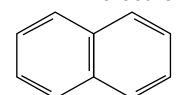

Naphthalene  $10\pi$

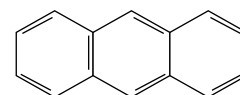

Anthracene  $14\pi$

Similarly cyclopentadienyl anion or tropylium ion are also aromatic because of containing  $6\pi$  electrons ( $n=1$ ).

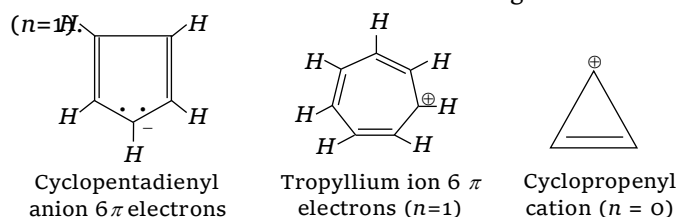

Heterocyclic compounds also have  $6\pi$  electrons ( $n=1$ ).

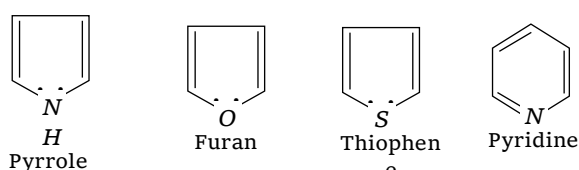

Molecules do not satisfy Huckel rule are not aromatic.

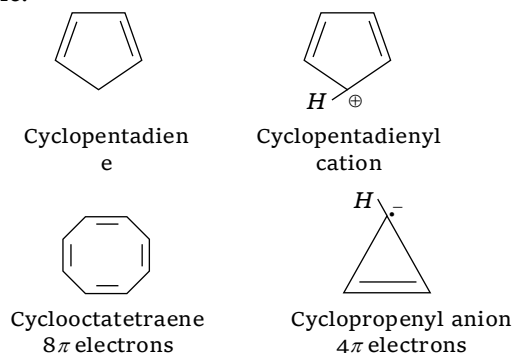

(4) **Antiaromaticity** : Planar cyclic conjugated species, less stable than the corresponding acyclic unsaturated species are called antiaromatic. Molecular orbital calculations have shown that such compounds have  $4n\pi$  electrons. In fact such cyclic compounds which have  $4n\pi$  electrons are called antiaromatic compounds and this characteristic is called antiaromaticity.

**Example** : 1,3-Cyclobutadiene, It is extremely unstable antiaromatic compound because it has  $4n\pi$  electrons ( $n=1$ ) and it is less stable than 1,3 butadiene by about  $83.6 \text{ KJ mol}^{-1}$ .

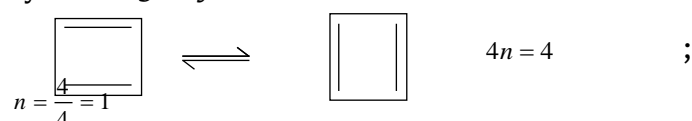

Thus, cyclobutadiene shows two equivalent contributing structures and it has  $n=1$ .

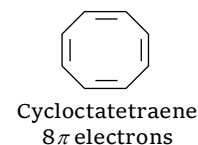
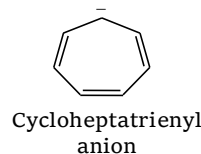
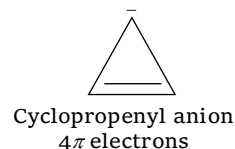
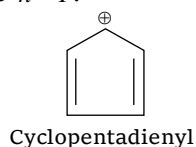

## Benzene ( $\text{C}_6\text{H}_6$ )

Benzene is the first member of arenes. It was first discovered by Faraday (1825) from whale oil. Mitscherlich (1833) obtained it by distilling benzoic acid with lime. Hofmann (1845) obtained it from coal tar, which is still a commercial source of benzene.

(1) **Structure of benzene** : Benzene has a special structure, which is although unsaturated even then it generally behaves as a saturated compound.

(i) **Kekule's structure** : According to Kekule, in benzene 6-carbon atoms placed at corner of hexagon and bonded with hydrogen and double bond present at alternate position.

(a) *Evidence in favour of Kekule's structure*

- Benzene combines with 3 molecules of hydrogen or three molecules of chlorine. It also combines with 3 molecules of ozone to form triozone. These reactions confirm the presence of three double bonds.

- Studies on magnetic rotation and molecular refraction show the presence of three double bonds and a conjugated system.

- The synthesis of benzene from three molecules of acetylene also favours Kekule's structure.

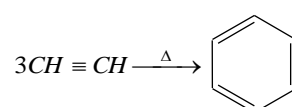

- Benzene gives cyclohexane by reduction with hydrogen.

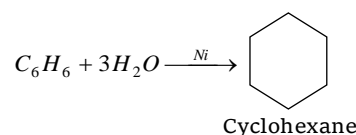

(b) *Objections against Kekule's formula*

- Unusual stability of benzene.
- According to Kekule, two ortho disubstituted products are possible. But in practice only one ortho disubstituted product is known.

- Heat of hydrogenation of benzene is  $49.8 \text{ kcal/mole}$ , whereas theoretical value of heat of hydrogenation of benzene is  $85.8 \text{ kcal/mole}$ . It means resonance energy is  $36 \text{ kcal/mole}$ .

## 1100 Hydrocarbon

• C–C bond length in benzene are equal, (although it contains 3 double bonds and 3 single bonds) and are 1.39 Å.

Kekule explained this objection by proposing that double bonds in benzene ring were continuously oscillating between two adjacent positions.

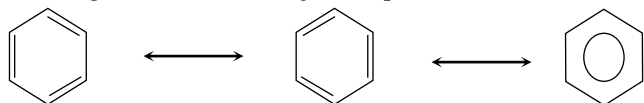

### (2) Methods of preparation of benzene

#### (i) Laboratory method :

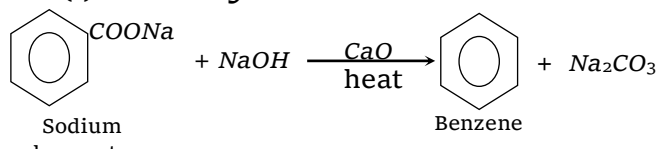

#### (ii) From benzene derivatives

##### (a) From phenol :



##### (b) From chlorobenzene :

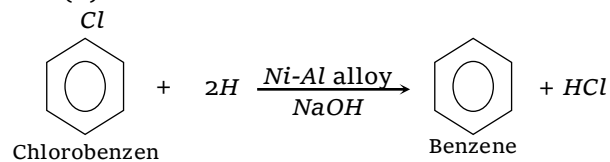

(c) By first preparing grignard reagent of chlorobenzene and then hydrolysed

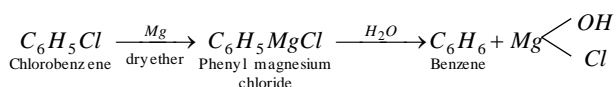

##### (d) From benzene sulphonic acid :

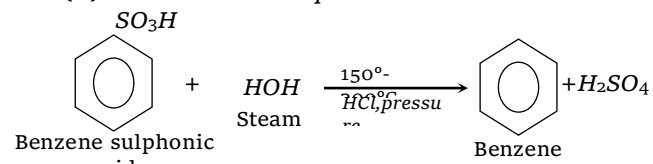

##### (e) From benzene diazonium chloride :

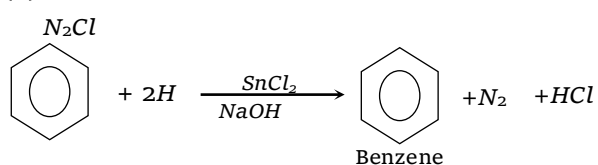

##### (f) From acetylene :

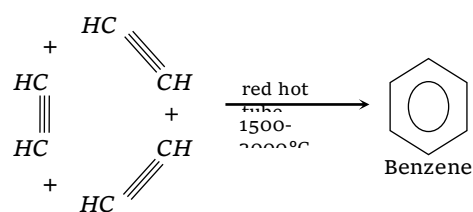

□ Cyclic polymerisation takes place in this reaction.

#### (g) Aromatisation :

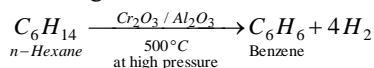

### (3) Properties of benzene

#### (i) Physical properties

(a) Benzene is a colourless, mobile and volatile liquid. It's boiling point is 80°C and freezing point is 5.5°C. It has characteristic odour.

(b) It is highly inflammable and burns with sooty flame.

(c) It is lighter than water. It's specific gravity at 20°C is 0.8788.

(d) It is immiscible with water but miscible with organic solvents such as alcohol and ether.

(e) Benzene itself is a good solvent. Fats, resins, rubber, etc. dissolve in it.

(f) It is a non-polar compound and its dipole moment is zero.

(g) It is an extremely poisonous substance. Inhalation of vapours or absorption through skin has a toxic effect.

(ii) **Chemical properties** : Due to the presence of π electron clouds above and below the plane benzene ring, the ring serves as a source of electrons and is easily attacked by electrophiles (Electron loving reagents). Hence electrophilic substitution reaction are the characteristic reactions of aromatic compounds.

Substitution reactions in benzene are preferred rather than addition are due to the fact that in the former reactions resonance stabilised benzene ring system is retained while the addition reactions lead to the destruction of benzene ring. Principal reactions of benzene can be studied under three heads,

(a) Addition reactions

(b) Substitution reactions

(c) Oxidation reactions

(a) **Addition reactions** : In which benzene behaves like unsaturated hydrocarbon.

Addition of hydrogen : Benzene reacts with hydrogen in the presence of nickel (or platinum) as catalyst at 150°C under pressure to form cyclohexane.

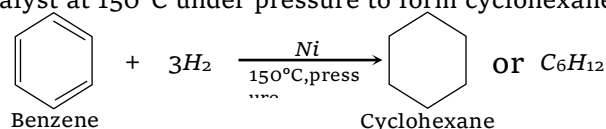

Addition of halogen :

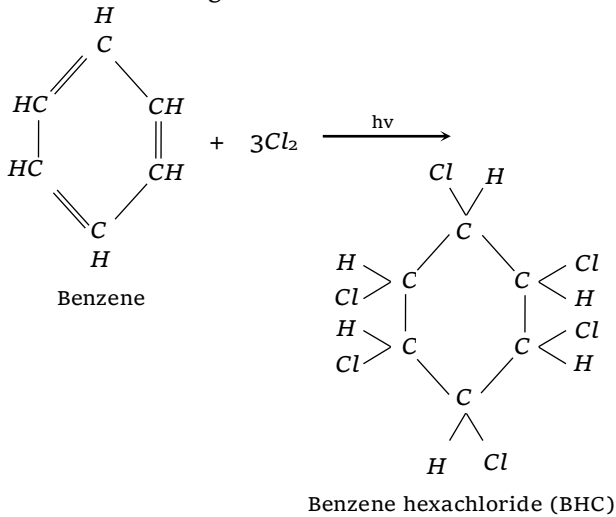

Addition of ozone :

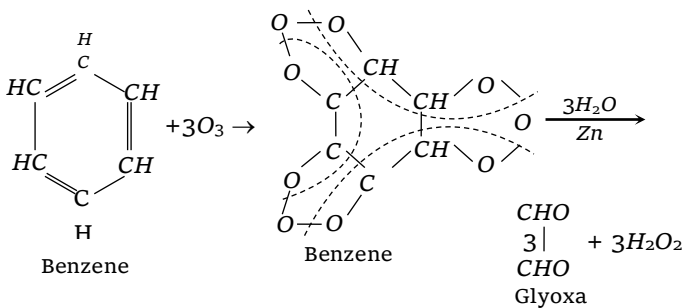

(b) Substitution reactions :

Nucleophilic substitution :

Unimolecular : Mostly uncommon in aromatic substitution, there is only one example which obtain in benzene diazonium dichloride.

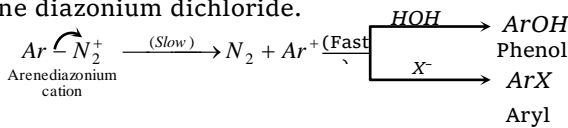

• Bimolecular :

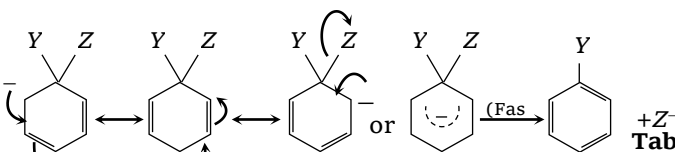
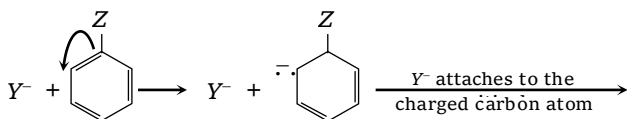
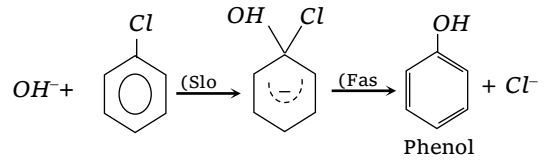
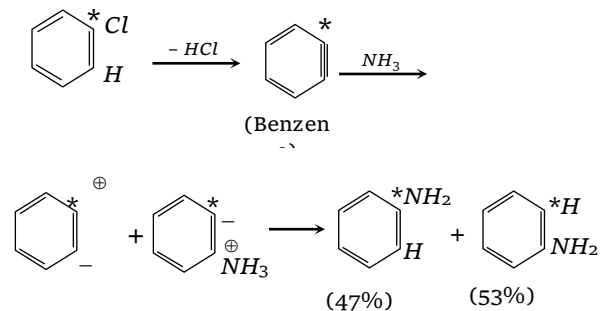

Table : 24.5

Example :



• Elimination-addition mechanism (Benzyne mechanism)



• Electrophilic substitution reaction : Benzene undergoes this reaction because it is an electron rich system due to delocalized π electrons.

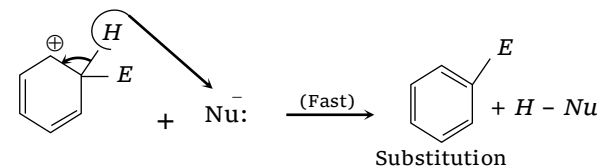
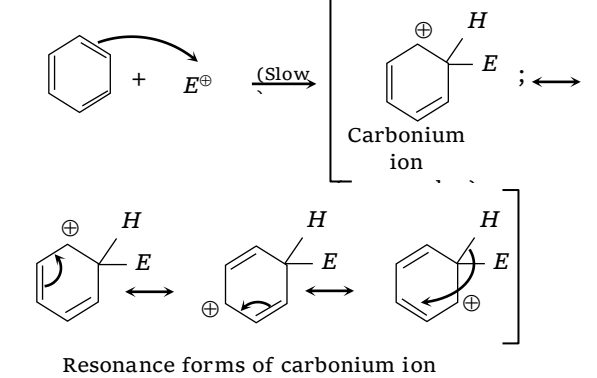

Electrophile (E <sup>+</sup> )	(Resonance structure of the Name)	Source	Name of substitution reaction
--------------------------------	-----------------------------------	--------	-------------------------------

## 1102 Hydrocarbon

$Cl^+$	Chloronium	$Cl_2 + AlCl_3$ or $FeCl_3$	Chlorination
$Br^+$	Bromonium	$Br_2 + AlBr_3$ or $FeBr_3$	Bromination
$NO_2^+$	Nitronium	$HNO_3 + H_2SO_4$	Nitration
$SO_3$	Sulphur trioxide	Conc. $H_2SO_4$ , Fuming sulphuric acid	Sulphonation
$R^+$	Alkyl carbonium	$RX + AlX_3$ ( $X = Cl$ or $Br$ ), $ROH + H^+$	Friedel-Craft's (Alkylation)
$R-\overset{+}{C}=O$	Acyl carbonium	$RCOCl + AlCl_3$	Friedel-Craft's (Acylation)

• Free radical aromatic substitution : The aromatic substitution reactions which follow free radical mechanisms are very few and have limited synthetic value. But some typical example of these reactions are:

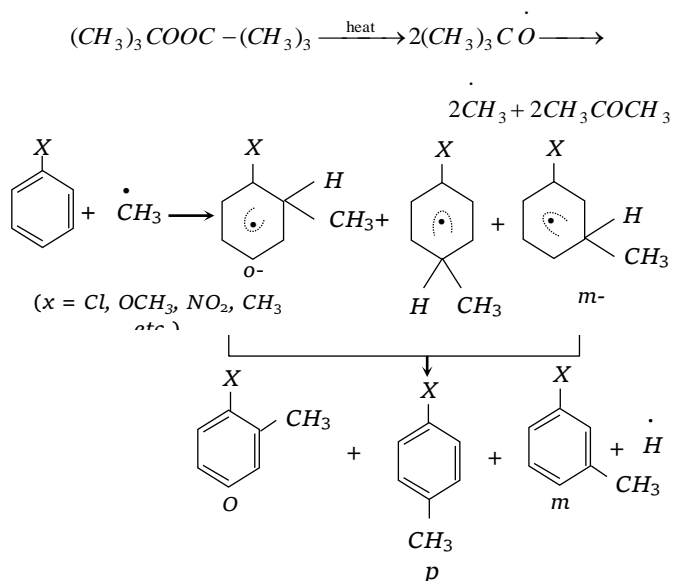

The mechanism of chlorination of benzene at high temperature is similar to that of the free radical aliphatic substitution

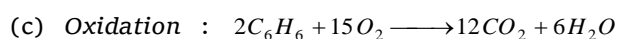
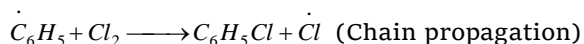
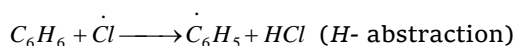
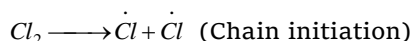

$$\Delta H = 6530 \text{ kJ/mole}$$

When vapours of benzene and air are passed over vanadium pentoxide at  $450 - 500^\circ C$ , maleic anhydride is obtained.

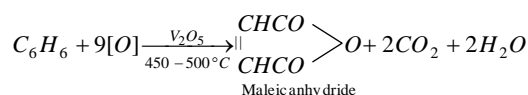

☐ Strong oxidising agents converts benzene slowly into  $CO_2$  and water on heating.

(d) Reduction :

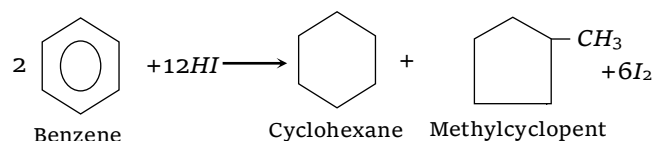

(iii) Uses : (a) In dry cleaning (b) As a motor fuel when mixed with petrol. (c) As a solvent. (d) In the manufacture of gammexane (As insecticide). (e) In the preparation of nitrobenzene, chlorobenzene, benzene sulphonic acid, aniline, styrene, etc. Many of these are employed for making dyes, drugs, plastics, insecticides, etc.

### Directive effect in substituted benzene derivatives

(1) Directive effect in mono substituted benzene derivatives : The substituent already present on the benzene ring directs the incoming substituent to occupy ortho (2 or 6), meta (3 or 5) or para (4) position. This direction depends on the nature of the first substituent and is called **directive or the orientation effect**.

The substituent already present can increase or decrease the rate of further substitution, i.e., it either activates or deactivates the benzene ring towards further substitution. These effects are called **activity effects**.

There are two types of substituents which produce directive effect are,

(i) Those which direct the incoming group to ortho- and para-positions simultaneously (Neglecting meta all together).

(ii) Those which direct the incoming group to meta-position only (Neglecting ortho- and para-positions all together).

Ortho-para directors	Meta directors
Strongly activating $-\ddot{N}H_2, -\ddot{N}HR, -\ddot{N}R_2, -\ddot{O}H, -\ddot{O}^-$	Moderately deactivating $-C \equiv N, -SO_3H, -COOH, -COOR, -CHO, COR$
Moderately activating $-\ddot{N}HCOCH_3, -\ddot{N}HCOR, -\ddot{O}R$	Strongly deactivating $-\text{NO}_2, -\text{NR}_3^{\oplus}, -\text{CF}_3, -\text{CCl}_3$
Weakly activating $-\text{CH}_3, -\text{C}_2\text{H}_5, -\text{R}, -\text{C}_6\text{H}_5$	
Weakly deactivating $-\ddot{F}, -\ddot{Cl}, -\ddot{Br}, -\ddot{I}$	

### Theory of ortho - para directing group

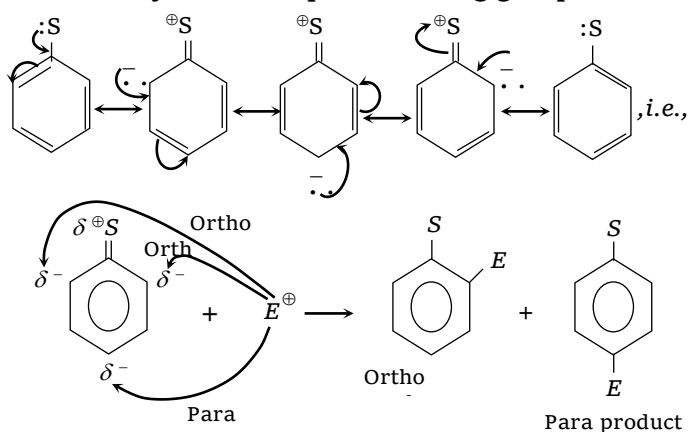

The above mechanism is followed when S is  $-\text{OH}, -\text{NH}_2, -\text{Cl}, -\text{Br}, -\text{I}, -\text{OR}, -\text{NR}_2, -\text{NHCOR}$  etc.

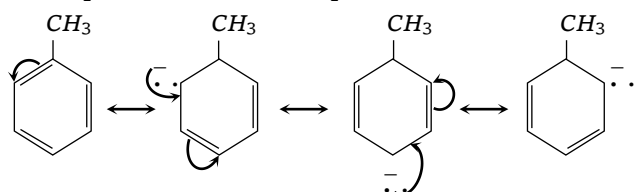

In methyl or alkyl group, the +I effect of the methyl group or alkyl group initiates the resonance effect.

Thus, methyl or alkyl group directs all electrophiles to ortho and para positions.

**Theory of meta directing group :** The substituent, S withdraws electrons from ortho and para positions. Thus, *m*-position becomes a point of relatively high electron density and further substitution by electrophile occurs at meta position. For example,  $-\text{NO}_2$  group is a meta directing (Electron withdrawing). Its mechanism can be explained as :

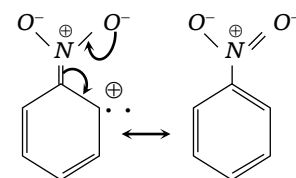
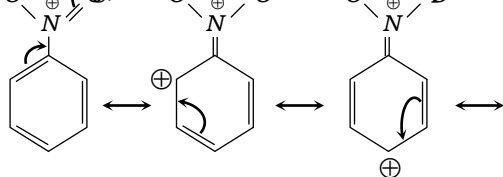

All meta-directing groups have either a partial positive charge or a full positive charge on the atom directly attached to the ring.

### (2) Directive effect in disubstituted benzene

(i) If the directive effects of two substituents reinforce, then a single product is formed.

Example :

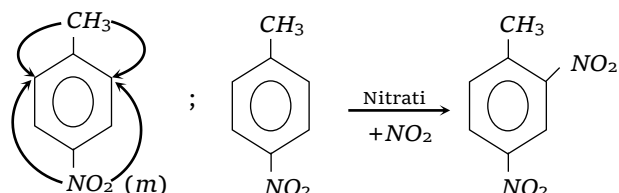

Thus, both  $(\text{CH}_3, \text{NO}_2)$  direct further substitution to the same position (Ortho with respect to  $\text{CH}_3$ ).

(ii) If the directing effect of two groups oppose each other strongly activating groups win over deactivating or weakly activating group. The sequence of directing power is

$-\text{NH}_2 > -\text{OH} > -\text{OCH}_3 > -\text{NHCOR} > -\text{C}_6\text{H}_5 > \text{CH}_3 >$   
meta directors

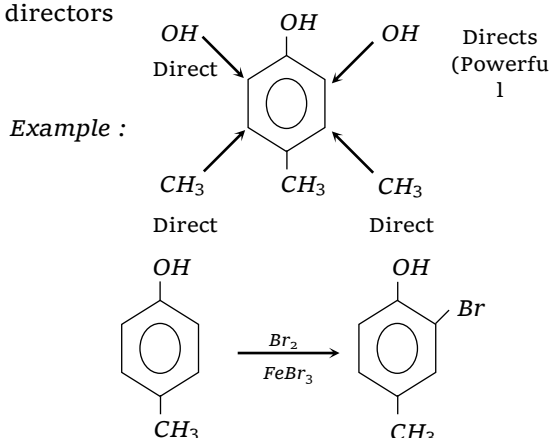

(iii) There is normally little substitution when the two groups are meta to each other. Aromatic rings with three adjacent substituents are generally prepared by some other routes.

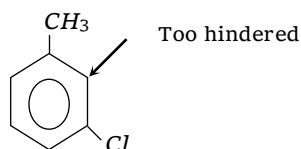

### Toluene, methyl benzene or phenyl methane

Toluene is the simplest homologue of benzene. It was first obtained by dry distillation of tolu balsam and hence named toluene. It is commercially known as toluol.

#### (1) Methods of preparation

(i) **From benzene** [Friedel-Craft's reaction] :

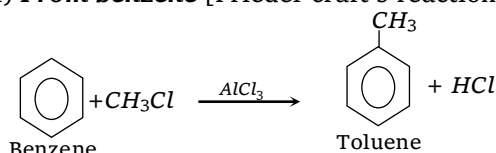

□ Alkyl halide employed may undergo an isomeric change

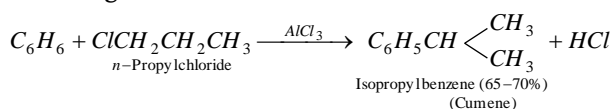

□ Catalysts can be used in place of anhydrous  $AlCl_3$  are,

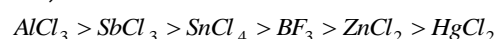

(ii) **Wurtz fitting reaction** :

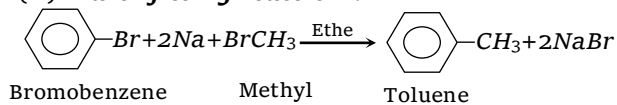

(iii) **Decarboxylation** :

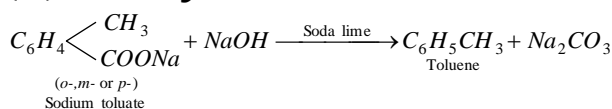

(iv) **From cresol** :

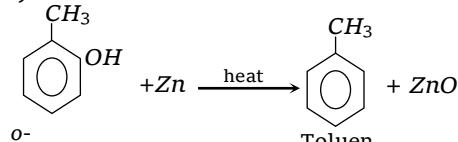

(v) **From toluene sulphonic acid** :

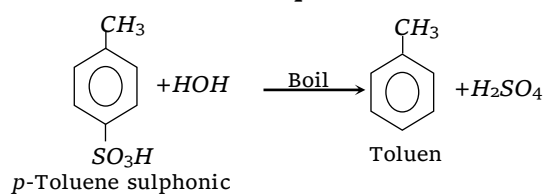

(vi) **From toluidine** :

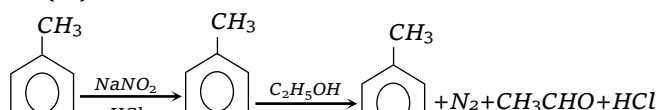

(vii) **From grignard reagent** :

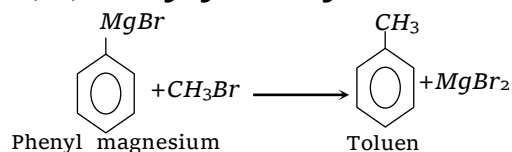

(viii) **Commercial preparation**

**From coal tar** : The main source of commercial production of toluene is the light oil fraction of coal-tar. The light oil fraction is washed with conc.  $H_2SO_4$  to remove the bases, then with  $NaOH$  to remove acidic substances and finally with water. It is subjected to fractional distillation. The vapours collected between  $80-110^\circ C$  is 90% benzol which contains 70–80% benzene and 14–24% toluene. 90% benzol is again distilled and the portion distilling between  $108-110^\circ C$  is collected as toluene.

(ix) **From *n*-heptane and methyl cyclohexane**

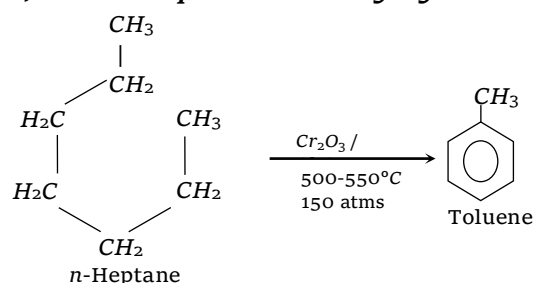

(2) **Physical properties**

(i) It is a colourless mobile liquid having characteristic aromatic odour.

(ii) It is lighter than water (*sp. gr.* 0.867 at  $20^\circ C$ ).

(iii) It is insoluble in water but miscible with alcohol and ether in all proportions.

(iv) Its vapours are inflammable. It boils at  $110^\circ C$  and freezes at  $-96^\circ C$ .

(v) It is a good solvent for many organic compounds.

(vi) It is a weak polar compound having dipole moment 0.4D.

(3) **Chemical properties** : Toluene shows the behaviour of both an aliphatic and an aromatic compound.

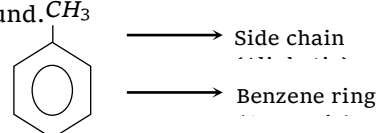



(i) **Electrophilic substitution reactions** :  
Aromatic character (More reactive than benzene) due to electron releasing nature of methyl group.

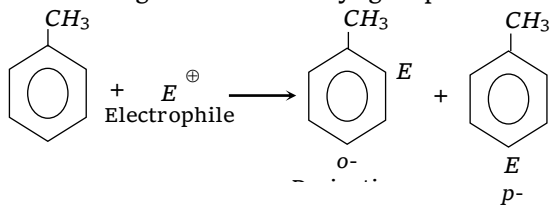

$E^+$  may be  $Cl^+$ ,  $NO_2^+$ ,  $SO_3^+$ ,  $H^+$  etc.

(ii) **Reactions of side chain**

(a) **Side chain halogenation** :

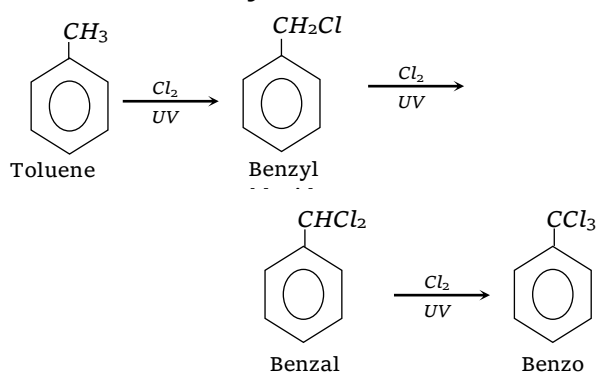

Benzyl chloride on hydrolysis with aqueous caustic soda forms benzyl alcohol.

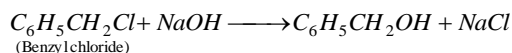

Benzal chloride on hydrolysis forms benzaldehyde.

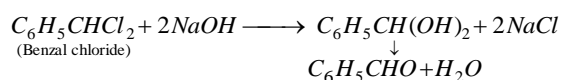

Benzo trichloride on hydrolysis forms benzoic acid.

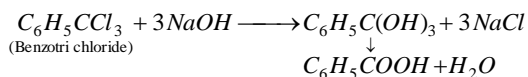

(b) **Oxidation** :

• With hot acidic  $KMnO_4$  :

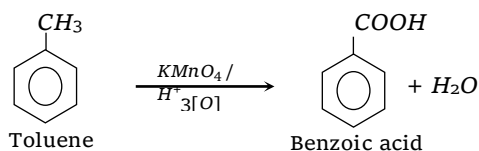

• With acidic manganese or chromyl chloride (Etard's reaction) :

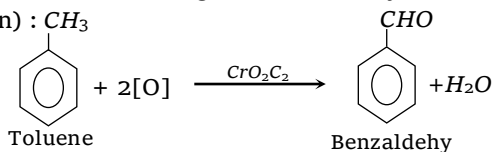

All alkyl benzenes on oxidation with hot acidic  $KMnO_4$  or  $Na_2Cr_2O_7$  form benzoic acid. The length of the side chain does not matter.

(c) **Hydrogenation** :

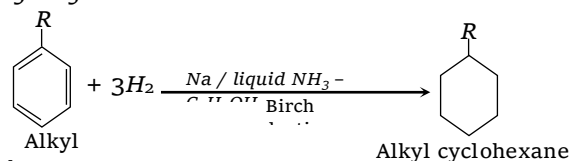

(d) **Combustion** :  $C_6H_5CH_3 + 9O_2 \longrightarrow 7CO_2 + 4H_2O$

(e) **Ozonolysis** :

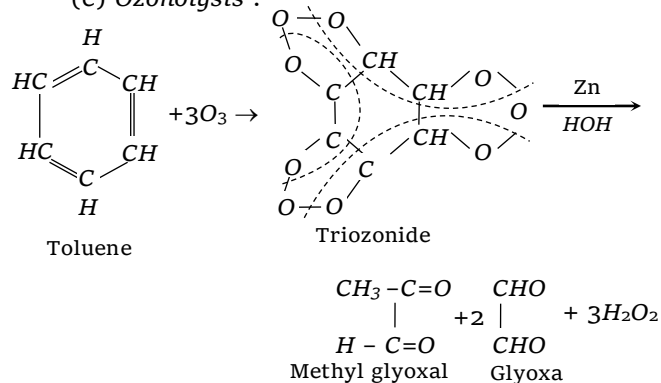

(4) **Uses**

(i) In the manufacture of benzyl chloride, benzal chloride, benzyl alcohol, benzaldehyde, benzoic acid, saccharin, etc.

(ii) In the manufacture of trinitrotoluene (TNT), a highly explosive substance.

(iii) As an industrial solvent and in drycleaning.

(iv) As a petrol substitute.

(v) In the manufacture of certain dyes and drugs.

**T.N.T. (Tri-nitro toluene)**

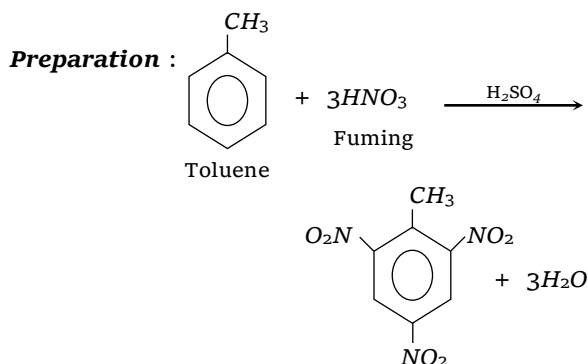

**Properties** : It is pale yellow crystalline solid (M.P. =  $81^\circ C$ ).

**Uses** : • It is used as an explosive in shells, bombs and torpedoes under the name trotyl.

• When mixed with 80% ammonium nitrate it forms the explosive **amatol**.

• TNT is also used as a mixture of aluminium nitrate, alumina and charcoal under the name **ammonal**.

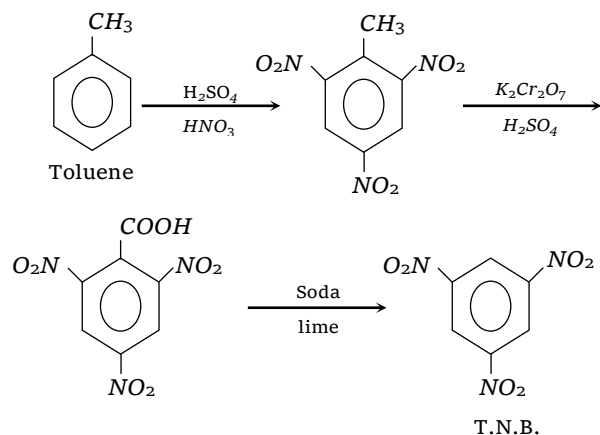

**T.N.B. (Tri-nitro benzene)****Preparation :**

**Properties and uses:** It is colourless solid (M.P. = 122°C). It is more explosive than T.N.T. and used for making explosive.

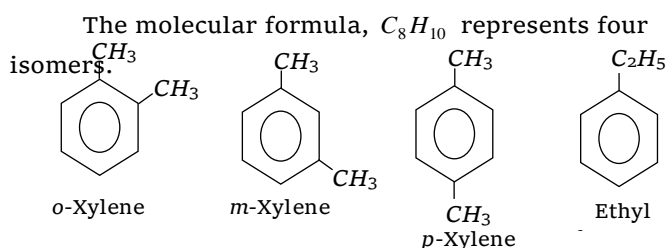
**Xylenes (Dimethyl benzene)  $C_6H_4(CH_3)_2$** 

These are produced along with benzene, toluene and ethylbenzene when aromatisation of  $C_6 - C_8$  fraction of petroleum naphtha is done. The xylenes are isolated from the resulting mixture (BTX) by fractional distillation.

These can be prepared by Wurtz - Fittig reaction. A mixture of bromotoluene and methylbromide is treated with sodium in dry ethereal solution to form the desired xylene.

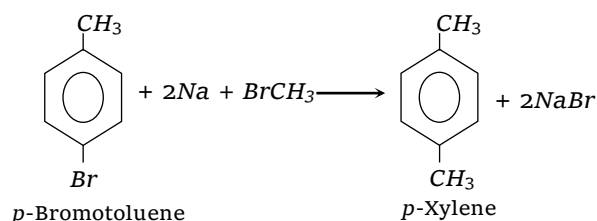
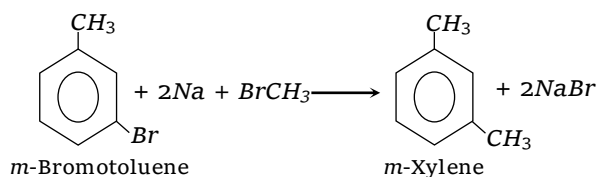
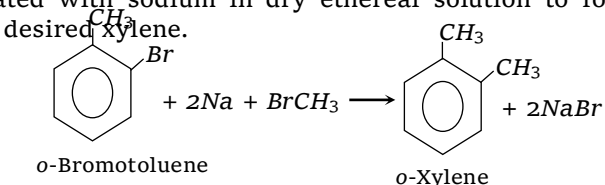

• These can also be obtained by Friedel - craft's synthesis,

• *m*-Xylene can be obtained from mesitylene.

Xylenes are colourless liquids having characteristic odour. The boiling points of three isomers are,

*o*-Xylene=144°C;      *m*-Xylene=139°C;      *p*-Xylene=138°C.

Xylenes undergo electrophilic substitution reactions in the same manner as toluene. Upon oxidation with  $KMnO_4$  or  $K_2Cr_2O_7$ , Xylenes form corresponding dicarboxylic acids.

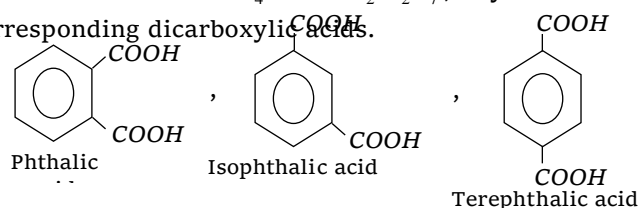

Xylenes are used in the manufacture of lacquers and as solvent for rubber. *o*-Xylene is used for the manufacture of phthalic anhydride.

**Ethyl benzene ( $C_6H_5C_2H_5$ )**

It can be prepared by the following reactions,

(1) **By Wurtz-Fittig reaction :**

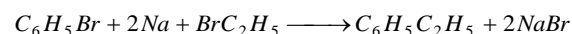

(2) **By Friedel-craft's reaction :**

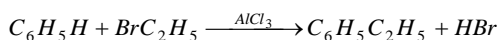

(3) **By catalytic reduction of styrene :**

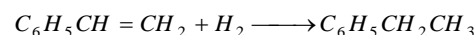

(4) **By alkyl benzene synthesis :**

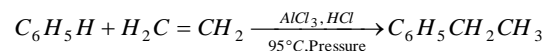

It undergoes electrophilic substitution reactions in the same way as toluene. When oxidised with dil.  $HNO_3$  or alkaline  $KMnO_4$  or chromic acid it forms benzoic acid.

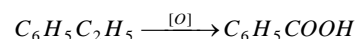
**Styrene ( $C_6H_5CH=CH_2$ )**

It is present in storax balsam and coal-tar in traces.

(1) **Preparation**

(i) **Dehydrogenation of side chain of ethylbenzene :**

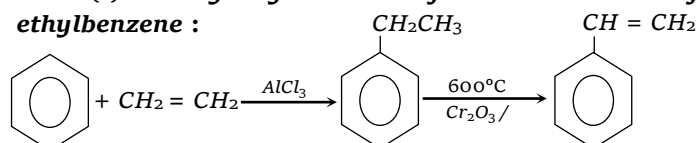

(ii) **Decarboxylation of cinnamic acid** : This is the laboratory preparation and involves heating of cinnamic acid with a small amount of quinol.

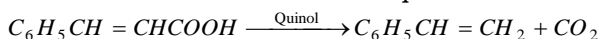

(iii) **Dehydration of 1-phenyl ethanol with  $H_2SO_4$**

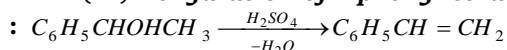

(iv) **Dehydration of 2-phenyl ethanol with  $ZnCl_2$**

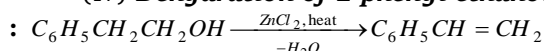

(v) **Dehydrohalogenation of 1-phenyl-1-chloroethane** : On heating with alcoholic potassium hydroxide, a molecule of hydrogen chloride is eliminated by the chloroderivative.

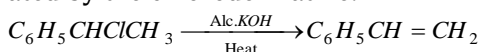

(2) **Properties** : It is a colourless liquid, boiling point  $145^\circ\text{C}$ . On keeping, it gradually changes into a solid polymer called **metastyrene**. The polymerisation is rapid in sunlight or when treated with sodium. It shows properties of benzene ring (Electrophilic substitution) and unsaturated side chain (Electrophilic addition). However, the side chain double bond is more susceptible to electrophilic attack as compared to benzene ring.

At lower temperature and pressure, it reacts with hydrogen to produce ethylbenzene and at higher temperature and pressure, it is converted into ethyl cyclohexane.

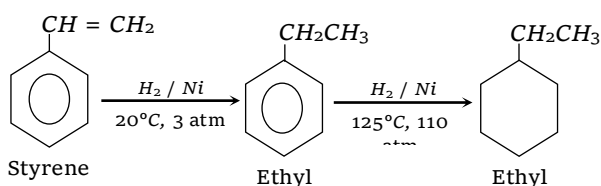

With bromine, it gives the dibromide.

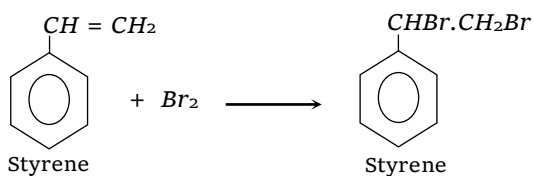

Halogen acids add to the side chain.

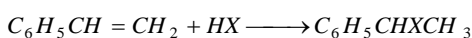

Preparation of ring substituted styrenes is not done by direct halogenation but through indirect route.

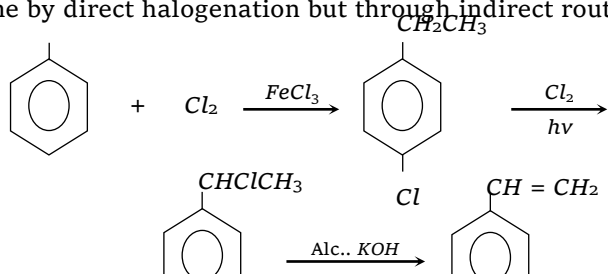

When oxidised under drastic conditions, the side chain is completely oxidised to a carboxyl group.

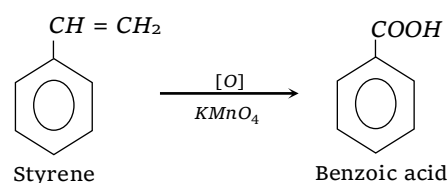

In presence of peroxides, styrene undergoes free radical polymerisation resulting in the formation of polystyrene – an industrially important plastic.

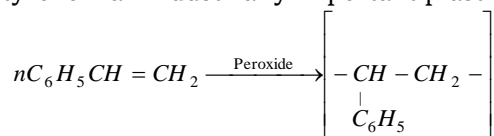

Co-polymers of styrene with butadiene and other substances are also important since many of them are industrially useful products such as **SBR** (A rubber substitute).

### Bi-phenyl ( $C_6H_5 - C_6H_5$ )

It occurs in coal-tar. It is the simplest example of an aromatic hydrocarbon in which two benzene rings are directly linked to each other.

#### (1) Methods of formation

(i) **Fittig reaction** : It consists heating of an ethereal solution of bromobenzene with metallic sodium.

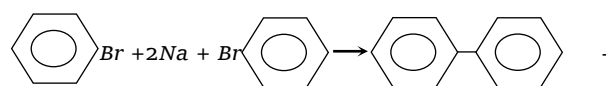

(ii) **Ullmann biaryl synthesis** : Iodobenzene, on heating with copper in a sealed tube, forms biphenyl. The reaction is facilitated if a strong electron withdrawing group is present in ortho or para position.

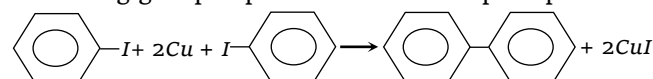

(iii) **Grignard reaction** : Phenyl magnesium bromide reacts with bromobenzene in presence of  $CoCl_2$ .

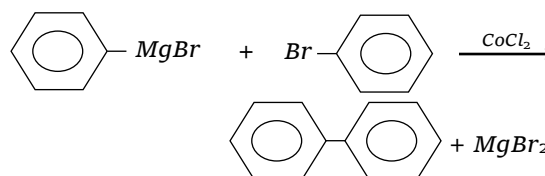

## 1108 Hydrocarbon

(2) **Properties** : It is a colourless solid, melting point  $71^{\circ}\text{C}$ . It undergoes usual electrophilic substitution reactions. Since aryl groups are electron withdrawing, they should have deactivating and *m*-orientating effect. But, it has been experimentally shown that presence of one benzene ring activates the other for electrophilic substitution and directs the incoming group to *o*- and *p*- positions. It has been shown that monosubstitution in the bi-phenyl results in the formation of para isomer as the major product.

Another special feature of the biphenyl is the behaviour towards second substitution in a monosubstituted biphenyl. The second substituent invariably enters the unsubstituted ring in the ortho and para position no matter what is the nature of substituent already present.

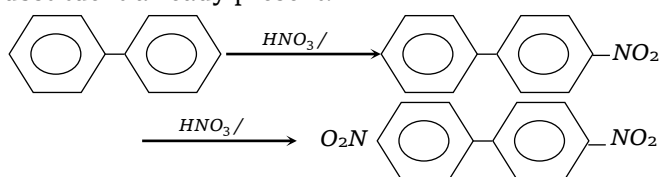

It reduces alkenes and alkynes while other common functional groups such as  $\text{C}=\text{O}$ ,  $\text{NO}_2$  and  $\text{C}\equiv\text{N}$  remain unaffected,

✍ The order of reactivity of primary ( $1^{\circ}$ ), secondary ( $2^{\circ}$ ) and tertiary ( $3^{\circ}$ ) hydrogens in alkanes follows the sequence :  $3^{\circ} > 2^{\circ} > 1^{\circ}$ .

## Tips & Tricks

✍ Octane number may be less than zero (e.g., *n*-Nonane has an octane number -45) and higher than 100 (e.g., Triptane or 2, 3, 3-Trimethylbutane has an octane number of 124).

✍ To avoid lead pollution, a new compound cyclopentadienyl manganese carbonyl

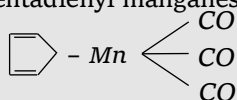

(called as AK-33-X) is used as antiknock now a days in developed countries (unleaded petrol).

✍ Acetylene has a garlic odour when impure due to impurities of phosphine and hydrogen sulphide.

✍ Fluorination is a violent reaction and can be controlled by diluting fluorine with nitrogen.

✍ The relative acidic character of water, alcohols acetylene, ammonia, ethylene and ethane follows the order :

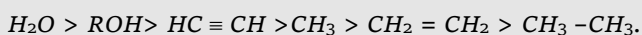

Obviously, the basic character of their conjugate bases follows the reverse order, i.e.,



✍ **Wilkinson's catalyst** : (Triphenylphosphine) rhodium,  $(\text{PPh}_3)_3 \text{RhCl}$  is called wilkinson's catalyst.